

江花®
JIANGHUA

**HYG1 SERIES
TUBE FITTINGS**

双卡套管接头



镇江市华阳机电制造有限公司
ZHENJIANG HUAYANG M&E MANUFACTURING CO., LTD

2006 年 3 月
Revised, March 2006

简介

江花®双卡套管接头是我公司在引进国外先进技术的基础上设计生产的一种高质量的管路连接系统，专门设计应用于化学工业、石油化工、电力、造船业、造纸业、轻工业等行业的仪器仪表应用、过程控制系统及动力系统等方面，同样在要求高质量管接头的其它领域也有广泛的应用。

Introduction

江花® Double Ferrules Tube Fitting is a designed and manufactured high quality connections system based on the advanced technology of foreign countries. It has been specifically designed for use on instrumentation, process and control systems and power system employed in chemical, petroleum, power generating, shipbuilding and paper making plants. It has also found extensive application in other fields where a high quality tube fitting is required.

工作原理

江花®双卡套管接头由四外部份组成：1) 接头体，2) 前卡套，3) 后卡套，4) 螺母。

在螺母拧紧的情况下，后卡套被推动，抵撞前卡套的后锥面，前卡套受推力驱动，进入接头体的锥孔，在管子上收缩变形，并在管子与接头体之间形成紧密的密封面，后卡套沿前卡套的内锥向内移动，深深陷入管子并对管子形成强有力的机械夹紧。

How 江花® Tube Fittings Work

江花® Double Ferrules Tube Fitting is composed of four parts:

- 1) body
- 2) front ferrule
- 3) back ferrule
- 4) nut

If the nut scwew down, The back ferrule is driven against the tapered rear of the front ferrule and the front ferrule is driven by force into the tapered mouth of the body. The front ferrule swages onto the tube as it moves down the body seat creating a pressure-tight seal on both tube and body. The back ferrule then moves inwards in the cone of the front ferrule, forming into the tube and creating a strong mechanical hold on the tube.

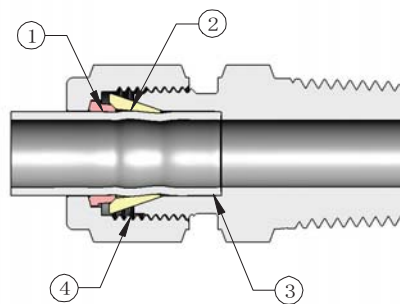
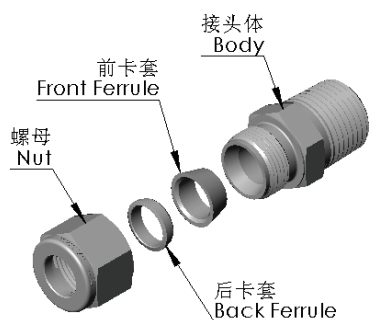

- ① 后卡套提供强劲的夹紧力，夹住管道，防止震动。

The back ferrule provides a strong mechanical and anti-vibration hold on the tube.

- ② 前卡套在接头体与管道上形成密封面

Pressure seal by front ferrule on tube and body

- ③ 管子承插孔底有微小的锥度，减小管子粘滞的可能性，并且能结束螺母与接头体的公差，使管子精确定位。

Slight taper in the base of the tube socket reduces possibility of tube sticking and close tolerance of nut and body for accurate tube alignment.

- ④ 镀银的螺母螺纹：确保接头体螺纹无损伤，使产品在高温下仍具有较长的使用寿命

Silver-plated Nut Thread : Silver-plated nut ensures no galling of body threads, Extended product life at extreme temperatures.

管接头
Tube to Tube Unions

Union直通中间接头

G1UM
G1U
Page 5

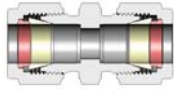

Reducing Union直通变径接头

G1RUM
G1RU
Page 6



Conversion Union直通转换接头

G1CU
Page 7



Bulkhead Union直通穿板接头

G1BUM
G1BU
Page 8



Bulkhead Reducing Union
穿板式变径直通接头

G1BRU
Page 7



Union Elbow 弯通中间接头

G1EM
G1E
Page 9

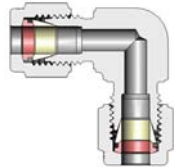

Reducing Union Elbow
异径弯通中间接头

G1REM
G1RE
Page 10

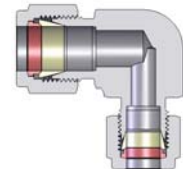

Union Tee 三通中间接头

G1TM
G1T
Page 11

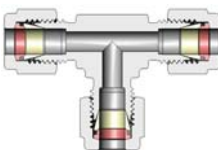

Reducing Union Tee异径三通接头

G1RTM
G1RT
Page 12

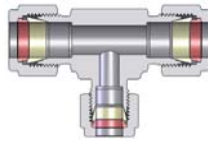

Union Cross

四通
G1CM
G1C
Page 13

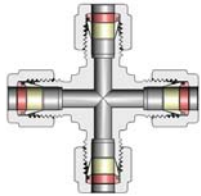

外螺纹终端接头
Tube to Male Pipe

Male Connector-NPT,BSPT
NPT, ISO圆锥外螺纹终端接头

G1MCM-N
G1MC-N
G1MCM-R
G1MC-R
Page 14,15,16,17

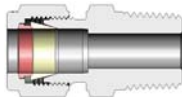

Male Connector-BSPP
ISO圆柱外螺纹直通终端接头,型式A

G1MCM-GA
G1MC-GA
Page 17,18



Male Connector-BSPP
ISO圆柱外螺纹直通终端接头,型式B

G1MCM-GB
G1MC-GB
Page 19,20

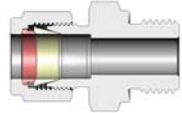

Male Connector-BSPP with ED Seal
ISO圆柱外螺纹终端接头,弹性密封

G1MCM-GED
G1MC-GED
Page 20

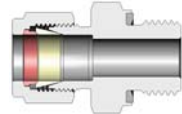

Male Elbow- NPT, BSPT Thread
NPT, ISO圆锥外螺纹弯通终端接头

G1MEM-N
G1ME-N
G1MEM-R
G1ME-R
Page 21,22,23

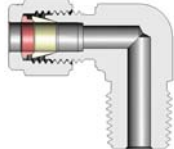

NPT Male Run Tee
NPT外螺纹直路三通终端接头

G1MRM
G1MRT
Page 24

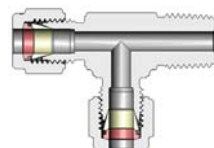

NPT Male Branch Tee

NPT外螺纹分支三通终端接头

G1MBTM
G1MBT
Page 25

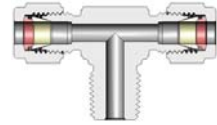

Adjustable Male Elbow - BSPP Thread
可调向外螺纹弯通终端接头-BSPP螺纹

G1AMEM-G
G1AME-G
Page 26

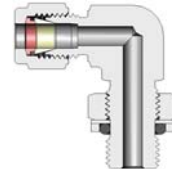

Adjustable Male Elbow - SAE/MS Thread
可调向外螺纹弯通终端接头-SAE/MS螺纹

G1AME-UN
Page 26

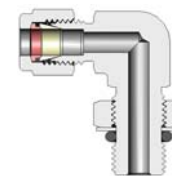

Adjustable Male Run Tee - BSPP Thread
可调向外螺纹直路三通终端接头

G1AMRTM-G
G1AMRT-G
Page 27

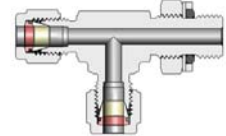

Adjustable Male Run Tee- SAE/MS Thread
可调向外螺纹直路三通终端接头

-SAE/MS螺纹
G1AMRT-UN
Page 27

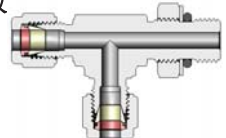

Adjustable Male Branch Tee - BSPP Thread
可调向外螺纹分支三通终端接头

-BSPP(G)螺纹
G1AMBTM-G
G1AMBT-G
Page 28

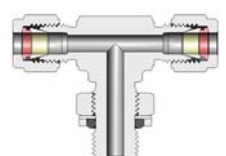

Adjustable Male Branch Tee
- SAE/MS Thread

可调向外螺纹分支三通终端接头
-SAE/MS螺纹
G1AMBT-UN
Page 28

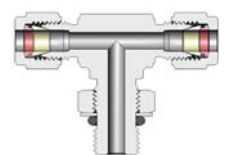

**内螺纹终端接头
Tube to Female Pipe**

**NPT Female Connector
NPT内螺纹终端接头**

G1FCM-N
G1FC-N
G1FCM-Rc
G1FC-Rc
Page 29, 30, 31

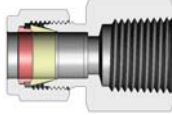

**Gauge Adapters
压力表接头**

GAM-G
GA-G
GAM-M
Page 32

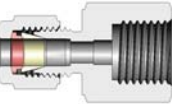

**NPT Female Elbow
NPT内螺纹弯通终端接头**

G1FEM-N
G1FE-N
Page 33

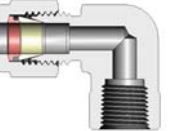

**NPT Female Run Tee
NPT内螺纹直路三通终端接头**

G1FRTM-N
G1FRT-N
Page 34

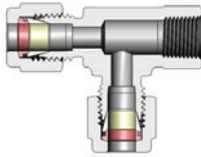

**NPT Female Branch Tee
NPT内螺纹分支三通终端接头**

G1FBTM-N
G1FBT-N
Page 35

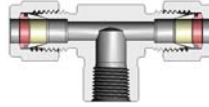

**焊接终端管接头
Tube to Weld End**

**Buttweld Connector
焊接直通接头**

G1BWCM
G1BWC
Page 36

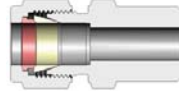

**Buttweld Elbow
焊接弯通接头**

G1BWEM
G1BWE
Page 37

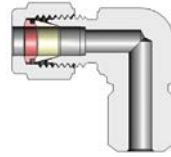

**Tube Socket weld Union
承插焊接直通接头**

G1SWCM
G1SWC
Page 38

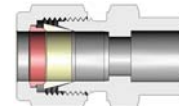

**Tube Socket weld Elbow
承插焊接弯通接头**

G1SWEM
G1SWE
Page 39

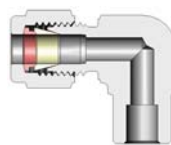

**其它
Others**

**Tube End Reducer
管梢变径接头**

G1TURM
G1TUR
Page 40, 41



**Tube End Converter
管梢转换接头**

G1TUCM
Page 42



Plug 堵头

G1PLM
G1PL
Page 42



Cap 管帽

G1CAPM
G1CAP
Page 43

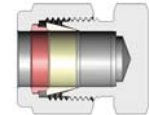

Fronf ferrule 前卡套

G1FFM
G1FF
Page 44



Back ferrule 后卡套

G1BFM
G1BF
Page 44



型号表示方法:

MODEL NUMBER DESCRIPTION:

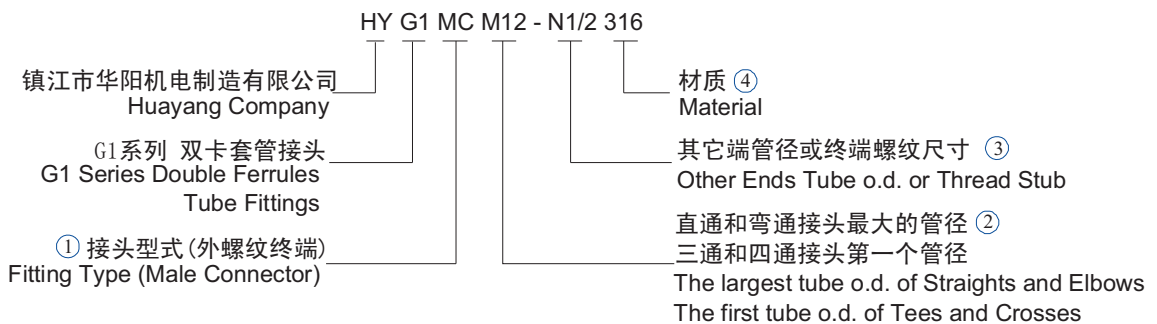

①接头型式表示方法: 一般为英文名称的缩写, 如:

The identification for Fitting Type: it's the abbreviation of English Name. Such as:

- U—直通管接头 Union
- E—弯通管接头 Union Elbow
- T—三通管接头 Union Tee
- MC—外螺纹接头 Male Connector
- FC—内螺纹管接头 Female Connector

其它型式参照索引 Other types cross index.

② **配管尺寸 Tube end size:**

直通和弯通接头: 最大的管端外径尺寸;
三通和四通接头: 第一个管端外径尺寸;
 米制管用毫米表示, 并加前缀M, 如: 12mm的管子表示为M12;
 英制管用英寸表示, 直接标注分数值, 如: 1/2" 的管子表示为1/2。

Straights & Elbows: The largest tube end size

Tees & Crosses: The first tube end size;

Metric tube is designated in millimeters and prefixed "M" (i.e. 12mm tube = M12).

Fractional tube is designated in inch, the size is written as a fraction (1/2 " tube = 1/2).

③ **其它端配管外径或终端螺纹尺寸**

Other ends tube o.d. or pipe thread size

其它端配管外径表示方法同②, 标注顺序如右图所示。

The designation of other tube end sizes are the same as ②, the order according to right fig.

终端螺纹尺寸用分数表示, 如: 1/4NPT = N1/4

The pipe thread size is written as a fraction (i.e. 1/4 NPT = N1/4).

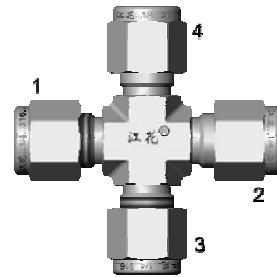

螺纹型式 Thread Types:

N=NPT	NPT螺纹	GB/T 12716, ANSI B 1.20.1
R=BSP Taper (male)	圆锥外螺纹	GB 7306, ISO 7/1, BS21, JIS B0203
Rc=BSP Taper (female)	圆锥内螺纹	GB 7306, ISO 7/1, BS21, JIS B0203
GA=BSPP Form A	管螺纹,密封型式A	GB 7307, ISO 228/1, BS2779, JIS B0202, DIN 3852 Form A
GB=BSPP Form B	管螺纹,密封型式B	GB 7307, ISO 228/1, BS2779, JIS B0202, DIN 3852 Form B
GED=BSPP Form E	管螺纹,弹性密封	GB 7307, ISO 228/1, BS2779, JIS B0202, DIN 3852
UN=Unified (SAE)	统一螺纹	ANSI B 1.1

④ **材料代号:**

Material Code:

304=304 Stainless Steel	不锈钢 0Cr18Ni9	GB/T 1220	产品编号中"#"代码 1	Code 1 in Products No.
316=316 Stainless Steel	不锈钢 0Cr17Ni12Mo2	GB/T 1220	产品编号中"#"代码 2	Code 2 in Products No.
316L=316L Stainless Steel	不锈钢 00Cr17Ni12Mo2	GB/T 1220	产品编号中"#"代码 3	Code 3 in Products No.
C = Carbon Steel	优质碳素结构钢20#	GB/T 699	产品编号中"#"代码 4	Code 4 in Products No.
BR= Brass	黄铜 H62	GB/T 4424	产品编号中"#"代码 5	Code 5 in Products No.

米制管接头与英制管接头的外形区别与标识

Physical Differences and Marking for Metric tube fitting and fractional products

米制管接头: 螺母和接头体上加工有台阶, 并标识为: 江花..12M..316..

英制管接头: 螺母与接头体上无台阶, 标识为: 江花..1/2OD..316..

Metric Nut: Stepped shoulder Marked: 江花..12M..316..

Metric body: Stepped shoulder

Inch Nut: No shoulder

Marked: 江花..1/2OD..316..

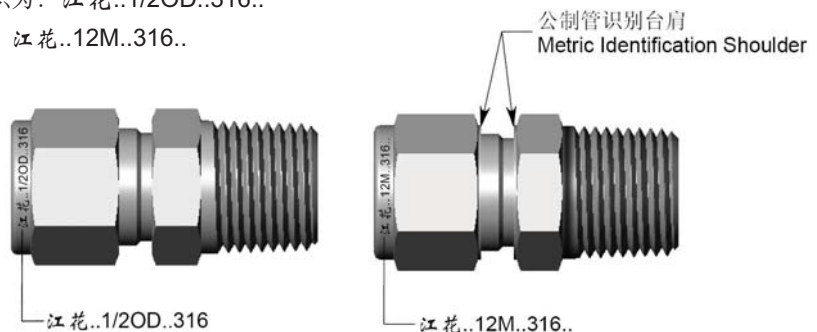

UM
直通中接头 (米制管)
Union (For metric tube)

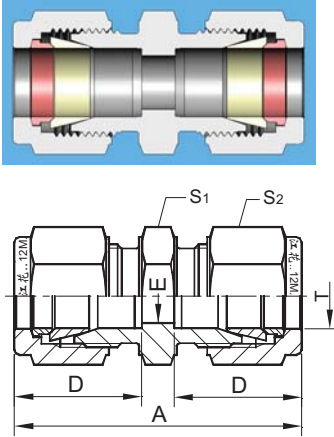

Tube O.D. T	A	D	E	S1	S2	Product No. 产品编号	Type 型号
3	35.8	12.9	2.5	12	12	01001#01	G1UM3
4	39.4	14.5	2.5	12	12	01001#02	G1UM4
6	41.5	15.5	4.8	14	14	01001#03	G1UM6
8	44.5	16.7	6.5	15	17	01001#04	G1UM8
10	47.9	17.9	8.0	18	19	01001#05	G1UM10
12	51.6	22.8	9.5	22	22	01001#06	G1UM12
14	52.6	24.4	11.0	24	27	01001#07	G1UM14
15	52.6	24.4	12.0	24	27	01001#08	G1UM15
16	52.6	24.4	13.0	24	27	01001#09	G1UM16
18	59.4	26.9	15.0	27	30	01001#10	G1UM18
20	60.8	28.9	16.0	30	32	01001#11	G1UM20
22	61.2	29.1	18.5	30	32	01001#12	G1UM22
25	67.4	32.4	22.0	36	38	01001#13	G1UM25

U
直通中接头 (英制管)
Union (For fractional tube)

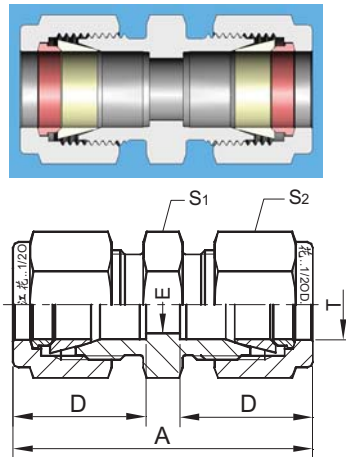

Tube O.D. T	A	D	E	S1	S2	Product No. 产品编号	Type 型号
1/8	35.9	12.9	2.5	12	12	01002#01	G1U1/8
3/16	39.6	14.6	3.0	12	12	01002#02	G1U3/16
1/4	41.5	15.5	5.0	14	14	01002#03	G1U1/4
5/16	44.5	16.7	6.5	15	17	01002#04	G1U5/16
3/8	47.5	17.9	7.0	17	18	01002#05	G1U3/8
1/2	51.6	22.9	10.5	22	22	01002#06	G1U1/2
5/8	52.5	24.4	13.0	24	27	01002#07	G1U5/8
3/4	59.3	26.9	16.0	27	30	01002#08	G1U3/4
7/8	61.1	29.1	18.5	30	32	01002#09	G1U7/8
1	67.4	32.5	22.0	36	38	01002#10	G1U1

注: 1)表中尺寸A和D为用手紧固后的尺寸, 后同。
2)尺寸仅供参考, 随时可能改变, 后同。
3)后面的接头同此。

NOTE: 1) A and C dimensions in tables are typical finger-tight.
2) Dimensions for reference only, subject to change.
3) The latters are same as it.

RUM

直通变径接头 (米制管)

Reducing Union (For metric tube)

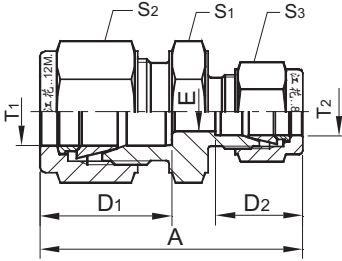
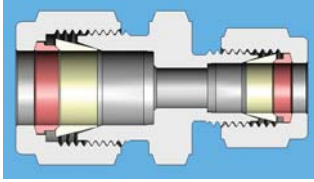

Tube O.D. T1	Tube O.D. T2	A	D1	D2	E	S1	S2	S3	Product No. 产品编号	Type 型号
6	3	38.9	15.5	12.9	2.5	14	14	12	01003#01	G1RUM6-3
	4	40.5		14.5	2.5			12	01003#02	G1RUM6-4
8	6	43.2	16.7	15.5	4.8	15	17	14	01003#03	G1RUM8-6
	8	46.6		16.7	6.5			17	01003#05	G1RUM10-8
10	6	45.4	17.9	15.5	4.8	18	19	14	01003#04	G1RUM10-6
	8	48.5		16.7	6.5			17	01003#07	G1RUM12-8
	10	49.7		17.9	8.0			19	01003#08	G1RUM12-10
12	6	47.3	22.8	15.5	4.8	22	22	14	01003#06	G1RUM12-6
	8	48.5		16.7	6.5			17	01003#07	G1RUM12-8
16	10	50.7	24.4	17.9	8.0	24	27	19	01003#09	G1RUM16-10
	12	52.6		22.8	9.5			22	01003#10	G1RUM16-12
18	12	56.7	24.4	22.8	9.5	27	30	22	01003#11	G1RUM18-12
	25	64.3	32.4	24.4	15.0	36	38	30	01003#12	G1RUM25-18
25	20	64.3	32.4	28.9	16.0	36	38	32	01003#13	G1RUM25-20

RU

直通变径接头 (英制管)

Reducing Union (For fractional tube)

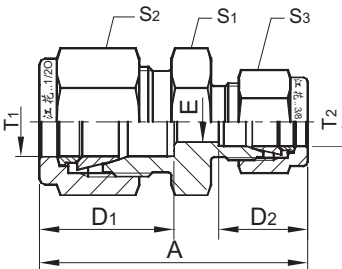
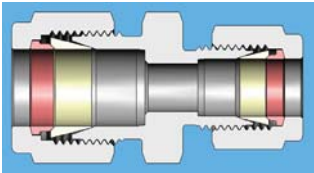

Tube O.D. T1	Tube O.D. T2	A	D1	D2	E	S1	S2	S3	Product No. 产品编号	Type 型号
3/16	1/8	38	14.6	12.9	2.5	12	12	12	01004#01	G1RU3/16-1/8
1/4	1/8	38.9	15.5	12.9	2.5	14	14	12	01004#02	G1RU1/4-1/8
	3/16	40.6		14.6	3.0			12	01004#03	G1RU1/4-3/16
5/16	1/8	40.6	16.7	12.9	2.5	15	17	12	01004#04	G1RU5/16-1/8
	1/4	43.2		15.5	5.0			14	01004#05	G1RU5/16-1/4
3/8	1/8	42.3	17.9	12.9	2.5	17	18	12	01004#06	G1RU3/8-1/8
	1/4	44.9		15.5	5.0			14	01004#07	G1RU3/8-1/4
	5/16	46.1		16.7	6.5			17	01004#08	G1RU3/8-5/16
1/2	1/8	44.7	22.8	12.9	2.5	22	22	12	01004#09	G1RU1/2-1/8
	1/4	47.3		15.5	5.0			14	01004#10	G1RU1/2-1/4
	3/8	49.7		17.9	7.0			18	01004#11	G1RU1/2-3/8
5/8	3/8	50.7	24.4	17.9	7	24	27	18	01004#12	G1RU5/8-3/8
	1/2	52.6		22.8	10.5			22	01004#13	G1RU5/8-1/2
3/4	1/4	52.4	24.4	15.5	5	27	30	14	01004#14	G1RU3/4-1/4
	3/8	54.8		17.9	7			18	01004#15	G1RU3/4-3/8
	1/2	56.7		22.8	10.5			22	01004#16	G1RU3/4-1/2
	5/8	56.7		24.4	13			27	01004#17	G1RU3/4-5/8
1	1/2	61.8	32.5	22.8	10.5	36	38	22	01004#18	G1RU1-1/2
	3/4	64.4		24.4	16			30	01004#19	G1RU1-3/4

CU

直通转换接头 (米制管-英制管)

Conversion Union

Metric Tube to Inch Tube

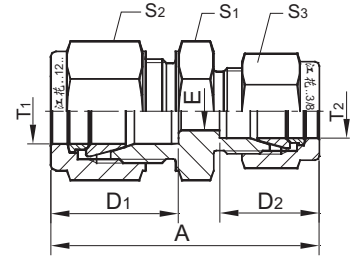
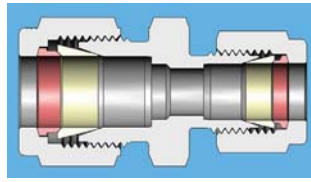

Tube O.D. T1	Tube O.D. T2	A	D1	D2	E	S1	S2	S3	Product No. 产品编号	Type 型号
3	1/8	36.3	12.9	12.9	2.5	10	12	12	01005#01	G1CU3-1/8
4	1/8	37.9	14.5	12.9	2.5	12	12	12	01005#02	G1CU4-1/8
4	1/4	40.6	14.5	15.5	2.5	12	12	14	01005#03	G1CU4-1/4
6	1/8	38.9	15.5	12.9	2.5	14	14	12	01005#04	G1CU6-1/8
6	1/4	41.6	15.5	15.5	4.8	14	14	14	01005#05	G1CU6-1/4
6	5/16	42.7	15.5	16.7	4.8	14	14	17	01005#06	G1CU6-5/16
8	1/8	40.6	16.7	12.9	2.5	15	17	12	01005#07	G1CU8-1/8
8	1/4	43.2	16.7	14.6	4.8	15	17	14	01005#08	G1CU8-1/4
8	3/8	46.1	16.7	17.9	6.5	15	17	18	01005#09	G1CU8-3/8
10	1/8	42.8	17.9	12.9	2.5	18	19	12	01005#10	G1CU10-1/8
10	1/4	45.4	17.9	15.5	4.8	18	19	14	01005#11	G1CU10-1/4
10	5/16	46.6	17.9	16.7	6.5	18	19	17	01005#12	G1CU10-5/16
10	3/8	47.8	17.9	17.9	7.0	18	19	18	01005#13	G1CU10-3/8
12	5/16	48.5	22.8	16.7	6.5	22	22	17	01005#14	G1CU12-5/16
12	3/8	49.7	22.8	17.9	7.0	22	22	18	01005#15	G1CU12-3/8
12	1/2	51.6	22.8	22.8	9.5	22	22	22	01005#16	G1CU12-1/2
15	1/2	52.6	24.4	22.8	10.5	24	27	22	01005#17	G1CU15-1/2
16	5/8	52.6	24.4	24.4	13.0	24	27	27	01005#18	G1CU16-5/8
18	3/4	59.3	24.4	24.4	15.0	27	30	30	01005#19	G1CU18-3/4

BRU

穿板式变径直通接头 (英制管)

Bulkhead Reducing Union

For Fractional Tube

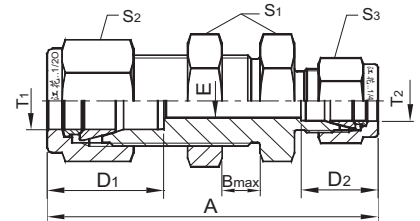
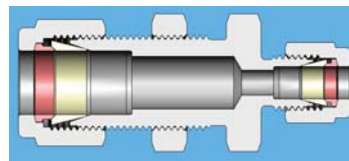

Tube O.D. T1	Tube O.D. T2	A	D1	D2	E	S1	S2	S3	Panel Hole Drill Size 面板孔尺寸	Max Panel Thickness 最大板厚	Product No. 产品编号	Type 型号
1/4	1/8	55.5	15.5	12.9	2.5	17	14	12	11.5	10.2	01006#01	BRU1/4-1/8
3/8	1/4	61.0	17.9	15.5	5.0	19	18	14	14.7	11.2	01006#02	BRU3/8-1/4
1/2	1/4	67.0	22.8	15.5	5.0	24	22	14	19.5	12.7	01006#03	BRU1/2-1/4

BUM

穿板式直通接头 (米制管)

Bulkhead Union (For metric tube)

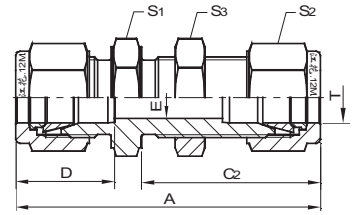
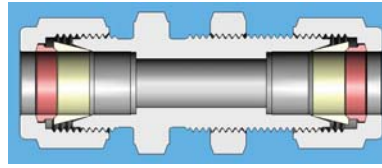

Tube O.D. T	A	D	C2	E	S1	S2	S3	Panel Hole Drill Size 面板孔尺寸	Max Panel Thickness 最大板厚	Product No. 产品编号	Type 型号
3	51.8	12.9	31.4	2.5	14	12	14	8.3	12.5	01007#01	G1BUM3
4	55.5	14.5	33	2.5	14	12	14	9.9	12.5	01007#02	G1BUM4
6	57	15.5	33.5	4.8	15	14	15	11.5	10.0	01007#03	G1BUM6
8	61.9	16.7	36.7	6.5	17	17	17	13.1	11.0	01007#04	G1BUM8
10	65.3	17.9	37.9	8.0	22	19	22	16.3	11.0	01007#05	G1BUM10
12	71.1	22.8	41.8	9.5	24	22	24	19.5	12.5	01007#06	G1BUM12
14	73.1	24.4	42.8	11.0	27	27	27	22.5	12.5	01007#07	G1BUM14
15	73.1	24.4	42.8	12.0	27	27	27	22.5	12.5	01007#08	G1BUM15
16	73.1	24.4	42.8	13.0	27	27	27	22.5	12.5	01007#09	G1BUM16
18	84.3	26.9	49.9	15.0	30	30	30	26.0	16.5	01007#10	G1BUM18
20	89.8	28.9	53.9	16.0	36	32	36	29.0	19.0	01007#11	G1BUM20
22	90.2	29.1	54.1	18.5	36	32	36	29.0	19.0	01007#12	G1BUM22
25	95	32.4	55.5	22.0	41	38	41	33.8	19.0	01007#13	G1BUM25

BU

穿板式直通接头 (英制管)

Bulkhead Union (For fractional tube)

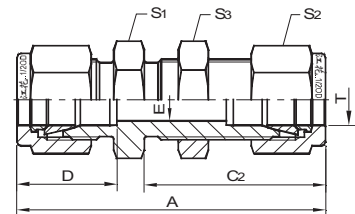
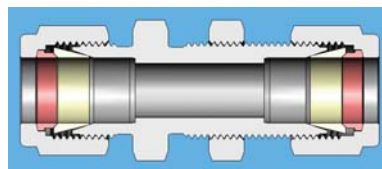

Tube O.D. T	A	D	C2	E	S1	S2	S3	Panel Hole Drill Size 面板孔尺寸	Max Panel Thickness 最大板厚	Product No. 产品编号	Type 型号
1/8	51.8	12.9	31.4	2.5	12	12	12	8.3	12.5	01008#01	G1U1/8
3/16	55.5	14.6	33.0	3.0	14	12	14	9.9	12.5	01008#02	G1U3/16
1/4	57	15.5	33.5	5.0	17	14	17	11.5	10.0	01008#03	G1U1/4
5/16	61.9	16.7	36.7	6.5	17	17	17	13.1	11.0	01008#04	G1U5/16
3/8	65.3	17.9	37.9	7.0	19	18	19	14.7	11.0	01008#05	G1U3/8
1/2	71.1	22.9	41.8	10.5	24	22	24	19.5	12.5	01008#06	G1U1/2
5/8	73.1	24.4	42.8	13.0	27	27	27	22.5	12.5	01008#07	G1U5/8
3/4	84.3	26.9	49.9	16.0	30	30	30	26.0	16.5	01008#08	G1U3/4
7/8	90.2	29.1	54.1	18.5	36	32	36	29.0	19.0	01008#09	G1U7/8
1	95	32.5	55.5	22.0	41	38	41	33.8	19.0	01008#10	G1U1

EM

弯通中接头 (米制管)

Union Elbow (For metric tube)

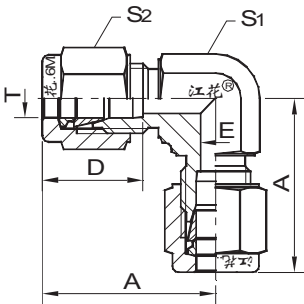
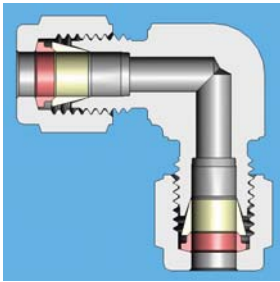

Tube O.D. T	A	D	E	S1	S2	Product No. 产品编号	Type 型号
3	22.6	12.9	2.5	9.5	12	01009#01	G1EM3
4	26.3	14.5	2.5	12.7	12	01009#02	G1EM4
6	27.1	15.5	4.8	12.7	14	01009#03	G1EM6
8	29.5	16.7	6.5	14.3	17	01009#04	G1EM8
10	32.3	17.9	8.0	17.5	19	01009#05	G1EM10
12	36.2	22.8	9.5	20.6	22	01009#06	G1EM12
14	38.3	24.4	11.0	23.8	27	01009#07	G1EM14
15	38.3	24.4	12.0	23.8	27	01009#08	G1EM15
16	38.3	24.4	13.0	23.8	27	01009#09	G1EM16
18	42.6	26.9	15.0	27.0	30	01009#10	G1EM18
20	47.4	28.9	16.0	34.9	32	01009#11	G1EM20
22	47.6	29.1	18.5	34.9	32	01009#12	G1EM22
25	50.3	32.4	22.0	34.9	38	01009#13	G1EM25

E

弯通中接头 (英制管)

Union Elbow (For fractional tube)

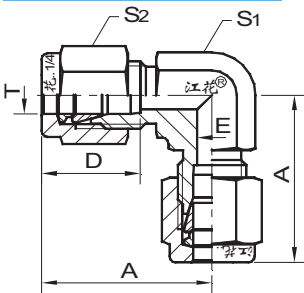
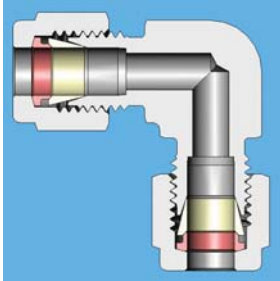

Tube O.D. T	A	D	E	S1	S2	Product No. 产品编号	Type 型号
1/8	22.6	12.9	2.5	9.5	12	01010#01	G1E1/8
3/16	26.3	14.6	3.0	12.7	12	01010#02	G1E3/16
1/4	27.1	15.5	5.0	12.7	14	01010#03	G1E1/4
5/16	29.5	16.7	6.5	14.3	17	01010#04	G1E5/16
3/8	31.4	17.9	7.0	15.9	18	01010#05	G1E3/8
1/2	36.2	22.9	10.5	20.6	22	01010#06	G1E1/2
5/8	38.3	24.4	13.0	23.8	27	01010#07	G1E5/8
3/4	42.6	26.9	16.0	27	30	01010#08	G1E3/4
7/8	47.6	29.1	18.5	34.9	32	01010#09	G1E7/8
1	50.3	32.5	22.0	34.9	38	01010#10	G1E1

REM

异径弯通中接头 (米制管)

Reducing Union Elbow (For metric tube)

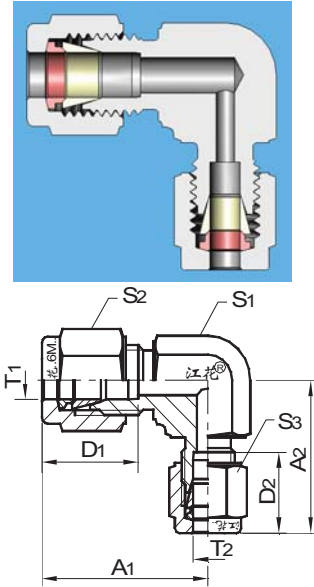

Tube O.D. T1	Tube O.D. T2	A1	A2	D1	D2	S1	S2	S3	Product No. 产品编号	Type 型号
6	3	27.1	24.5	15.5	12.9	12.7	14	12	01011#01	G1REM6-3
	4		26.1		14.5			12	01011#02	G1REM6-4
8	6	29.5	28.3	16.7	15.5	14.3	17	14	01011#03	G1REM8-6
	10	32.3	29.9	17.9	15.5	17.5	19	14	01011#04	G1REM10-6
12	8		31.1		16.7			17	01011#05	G1REM10-8
	6	36.2	31.9	22.8	15.5	20.6	22	14	01011#06	G1REM12-6
	8		33.1		16.7			17	01011#07	G1REM12-8
14	10		34.3		17.9			19	01011#08	G1REM12-10
	8	38.3	35.2	24.4	16.5	23.8	27	17	01011#09	G1REM14-8
15	10		36.4		17.9			19	01011#10	G1REM14-10
	12	38.3	38.3	24.4	22.8	23.8	27	22	01011#11	G1REM15-12
16	10	38.3	36.4	24.4	17.9	23.8	27	19	01011#12	G1REM16-10
	12		38.3		22.8			22	01011#13	G1REM16-12
	12	42.6	40	26.9	22.8	27	30	22	01011#14	G1REM18-12
20	12	47.4	44.8	28.9	22.8	34.9	32	22	01011#15	G1REM20-12
	25	18	50.3	47.2	32.4	26.9	34.9	38	30	01011#16
20			47.2		28.9			32	01011#17	G1REM25-20

RE

异径弯通中接头 (英制管)

Reducing Union Elbow (For fractional tube)

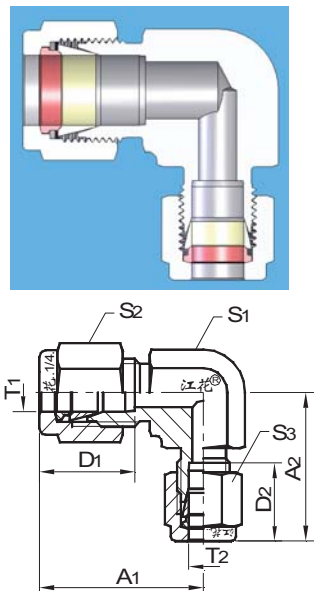

Tube O.D. T1	Tube O.D. T2	A1	A2	D1	D2	S1	S2	S3	Product No. 产品编号	Type 型号
3/16	1/8	26.3	24.7	14.6	12.9	12.7	12	12	01012#01	G1RE3/16-1/8
	1/4	27.1	24.5	15.5	12.9	12.7	14	12	01012#02	G1RE1/4-1/8
5/16	1/8	29.5	25.7	16.7	12.9	14.3	17	12	01012#03	G1RE5/16-1/8
	1/4		28.3		15.5			14	01012#04	G1RE5/16-1/4
3/8	1/8	31.4	26.4	17.9	12.9	15.9	18	12	01012#05	G1RE3/8-1/8
	1/4		29.0		15.5			14	01012#06	G1RE3/8-1/4
	5/16		30.2		16.7			17	01012#07	G1RE3/8-5/16
1/2	1/4	36.2	31.9	22.9	15.5	20.6	22	14	01012#08	G1RE1/2-1/4
	5/16		33.1		16.7			17	01012#09	G1RE1/2-5/16
	3/8		34.3		17.9			18	01012#10	G1RE1/2-3/8
5/8	3/8	38.3	36.4	24.4	17.9	23.8	27	18	01012#11	G1RE5/8-3/8
	1/2		38.3		22.8			22	01012#12	G1RE5/8-1/2
	3/4	42.6	37.2	26.9	15.5	27	30	14	01012#13	G1RE3/4-1/4
3/4	3/8		38.1		17.9			18	01012#14	G1RE3/4-3/8
	1/2		40		22.8			22	01012#15	G1RE3/4-1/2
	7/8	47.6	42	29.1	15.5	34.9	32	14	01012#16	G1RE7/8-1/4
1	1/2	50.3	44.6	32.5	22.8	34.9	38	22	01012#17	G1RE1-1/2
	3/4		47.2		26.9			30	01012#18	G1RE1-3/4

TM
三通中接头 (米制管)
Union Tee (For metric tube)

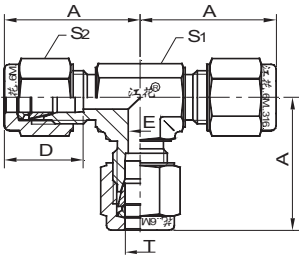
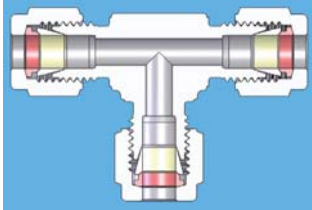

Tube O.D. T	A	D	E	S1	S2	Product No. 产品编号	Type 型号
3	22.3	12.9	2.5	9.5	12	01013#01	G1TM3
4	26.2	14.5	2.5	12.7	12	01013#02	G1TM4
6	27.2	15.5	4.8	12.7	14	01013#03	G1TM6
8	29.3	16.7	6.5	14.3	17	01013#04	G1TM8
10	32.2	17.9	8.0	17.5	19	01013#05	G1TM10
12	36.0	22.8	9.5	20.6	22	01013#06	G1TM12
14	38.8	24.4	11.0	23.8	27	01013#07	G1TM14
15	38.8	24.4	12.0	23.8	27	01013#08	G1TM15
16	38.8	24.4	13.0	23.8	27	01013#09	G1TM16
18	42.3	26.9	15.0	27.0	30	01013#10	G1TM18
20	47.5	28.9	16.0	34.9	32	01013#11	G1TM20
22	47.7	29.1	18.5	34.9	32	01013#12	G1TM22
25	50.2	32.4	22.0	34.9	38	01013#13	G1TM25

T
三通中接头 (英制管)
Union Tee (For fractional tube)

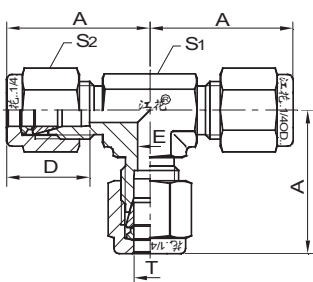
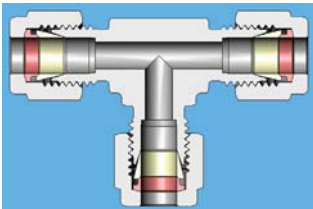

Tube O.D. T	A	D	E	S1	S2	Product No. 产品编号	Type 型号
1/8	22.6	12.9	2.5	9.5	12	01014#01	G1T1/8
3/16	26.3	14.6	3.0	12.7	12	01014#02	G1T3/16
1/4	27.2	15.5	5.0	12.7	14	01014#03	G1T1/4
5/16	29.9	16.7	6.5	14.3	17	01014#04	G1T5/16
3/8	31.6	17.9	7.0	15.9	18	01014#05	G1T3/8
1/2	36.1	22.9	10.5	20.6	22	01014#06	G1T1/2
5/8	38.1	24.4	13.0	23.8	27	01014#07	G1T5/8
3/4	42.4	26.9	16.0	27	30	01014#08	G1T3/4
7/8	47.8	29.1	18.5	34.9	32	01014#09	G1T7/8
1	50.3	32.5	22.0	34.9	38	01014#10	G1T1

RTM

异径三通中接头 (米制管)

Reducing Union Tee (For metric tube)

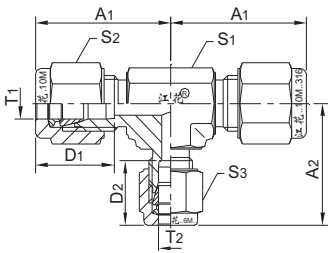
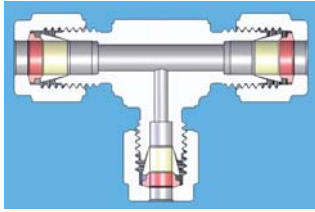

Tube O.D. T1	Tube O.D. T2	A1	A2	D1	D2	S1	S2	S3	Product No. 产品编号	Type 型号
6	3	27.1	24.5	15.5	12.9	12.7	14	12	01015#01	G1RTM6-3
	4		26.1		14.5			12	01015#02	G1RTM6-4
8	6	29.5	28.3	16.7	15.5	14.3	17	14	01015#03	G1RTM8-6
	8		31.1		16.7			17	01015#05	G1RTM10-8
10	6	32.3	29.9	17.9	15.5	17.5	19	14	01015#04	G1RTM10-6
	8		33.1		16.7			17	01015#07	G1RTM12-8
		10		34.3		17.9			19	01015#08
12	6	36.2	31.9	22.8	15.5	20.6	22	14	01015#06	G1RTM12-6
	8		33.1		16.7			17	01015#07	G1RTM12-8
		10		34.3		17.9			19	01015#08
14	8	38.3	35.2	24.4	16.5	23.8	27	17	01015#09	G1RTM14-8
	10		36.4		17.9			19	01015#10	G1RTM14-10
15	12	38.3	38.3	24.4	22.8			22	01015#11	G1RTM15-12
16	10	38.3	36.4	24.4	17.9			19	01015#12	G1RTM16-10
	12		38.3		22.8			22	01015#13	G1RTM16-12
18	12	42.6	40	26.9	22.8	27	30	22	01015#14	G1RTM18-12
20	12	47.4	44.8	28.9	22.8	34.9	32	22	01015#15	G1RTM20-12
25	18	50.3	47.2	32.4	26.9	34.9	38	30	01015#16	G1RTM25-18
	20		47.2		28.9	34.9	38	32	01015#17	G1RTM25-20

RT

异径三通中接头 (英制管)

Reducing Union Tee (For fractional tube)

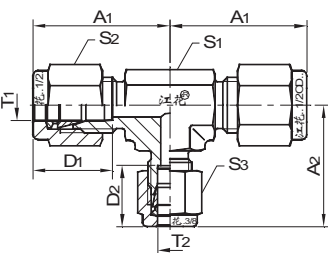
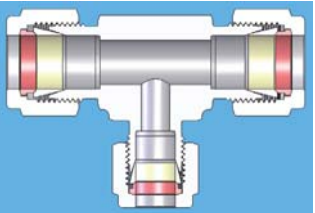

Tube O.D. T1	Tube O.D. T2	A1	A2	D1	D2	S1	S2	S3	Product No. 产品编号	Type 型号
3/16	1/8	26.3	24.7	14.6	12.9	12.7	12	12	01016#01	G1RT3/16-1/8
1/4	1/8	27.1	24.5	15.5	12.9	12.7	14	12	01016#02	G1RT1/4-1/8
	1/4		28.3		15.5	14.3	17	14	01016#04	G1RT5/16-1/4
5/16	1/8	29.5	25.7	16.7	12.9	14.3	17	12	01016#03	G1RT5/16-1/8
	1/4		28.3		15.5	14.3	17	14	01016#04	G1RT5/16-1/4
		3/8		30.2		16.7			17	01016#07
1/2	1/8	31.4	26.4	17.9	12.9	15.9	18	12	01016#05	G1RT3/8-1/8
	1/4		29.0		15.5			14	01016#06	G1RT3/8-1/4
		5/16		30.2		16.7			17	01016#07
1/2	1/4	36.2	31.9	22.9	15.5	20.6	22	14	01016#08	G1RT1/2-1/4
	5/16		33.1		16.7			17	01016#09	G1RT1/2-5/16
		3/8		34.3		17.9			18	01016#10
5/8	3/8	38.3	36.4	24.4	17.9	23.8	27	18	01016#11	G1RT5/8-3/8
	1/2		38.3		22.8			22	01016#12	G1RT5/8-1/2
3/4	1/4	42.6	37.2	26.9	15.5	27	30	14	01016#13	G1RT3/4-1/4
	3/8		38.1		17.9			18	01016#14	G1RT3/4-3/8
		1/2		40		22.8			22	01016#15
7/8	1/4	47.6	42	29.1	15.5	34.9	32	14	01016#16	G1RT7/8-1/4
1	1/2	50.3	44.6	32.5	22.8	34.9	38	22	01016#17	G1RT1-1/2
	3/4		47.2		26.9	34.9	38	30	01016#18	G1RT1-3/4

CM

四通中接头 (米制管)

Union Cross (For metric tube)

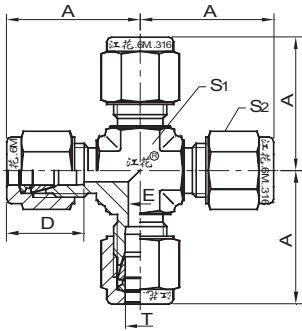
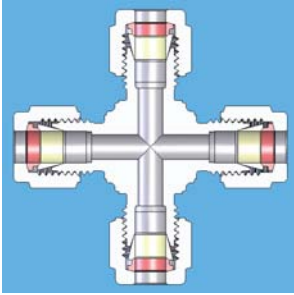

Tube O.D. T	A	D	E	S1	S2	Product No. 产品编号	Type 型号
3	22.3	12.9	2.5	9.5	12	01013#01	G1TM3
4	26.2	14.5	2.5	12.7	12	01013#02	G1TM4
6	27.2	15.5	4.8	12.7	14	01013#03	G1TM6
8	29.3	16.7	6.5	14.3	17	01013#04	G1TM8
10	32.2	17.9	8.0	17.5	19	01013#05	G1TM10
12	36.0	22.8	9.5	20.6	22	01013#06	G1TM12
14	38.8	24.4	11.0	23.8	27	01013#07	G1TM14
15	38.8	24.4	12.0	23.8	27	01013#08	G1TM15
16	38.8	24.4	13.0	23.8	27	01013#09	G1TM16
18	42.3	26.9	15.0	27	30	01013#10	G1TM18
20	47.5	28.9	16.0	34.9	32	01013#11	G1TM20
22	47.7	29.1	18.5	34.9	32	01013#12	G1TM22
25	50.2	32.4	22.0	34.9	38	01013#13	G1TM25

C

四通中接头 (英制管)

Union Cross (For fractional tube)

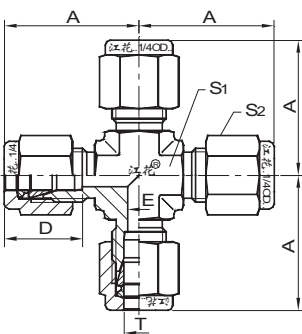
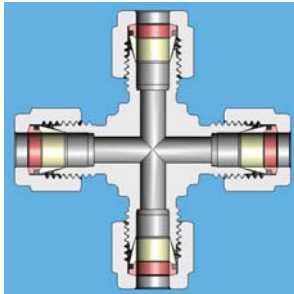

Tube O.D. T	A	D	E	S1	S2	Product No. 产品编号	Type 型号
1/8	22.6	12.9	2.5	9.5	12	01014#01	G1T1/8
3/16	26.3	14.6	3.0	12.7	12	01014#02	G1T3/16
1/4	27.2	15.5	5.0	12.7	14	01014#03	G1T1/4
5/16	29.9	16.7	6.5	14.3	17	01014#04	G1T5/16
3/8	31.6	17.9	7.0	15.9	18	01014#05	G1T3/8
1/2	36.1	22.9	10.5	20.6	22	01014#06	G1T1/2
5/8	38.1	24.4	13.0	23.8	27	01014#07	G1T5/8
3/4	42.4	26.9	16.0	27	30	01014#08	G1T3/4
7/8	47.8	29.1	18.5	34.9	32	01014#09	G1T7/8
1	50.3	32.5	22.0	34.9	38	01014#10	G1T1

MCM-N

NPT外螺纹终端接头 (米制管)

NPT Male Connector (For metric tube)

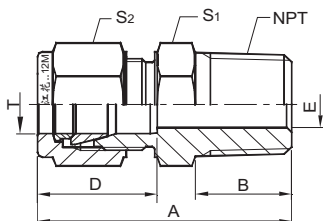
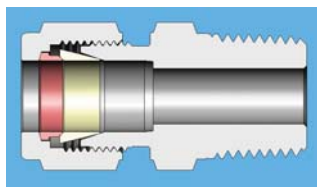

Tube O.D. T	NPT	A	B	D	E	S1	S2	Product No.	Type
								产品编号	型号
3	1/8	30.0	9.5	12.9	2.5	12	12	01015#01	G1MCM3-N1/8
	1/4	35.6	14.3		2.5	14		01015#02	G1MCM3-N1/4
4	1/8	32.1	9.5	14.5	2.5	12	12	01015#03	G1MCM4-N1/8
	1/4	37.2	14.3		2.5	14		01015#04	G1MCM4-N1/4
6	1/8	32.9	9.5	15.5	4.8	14	14	01015#05	G1MCM6-N1/8
	1/4	38.1	14.3		4.8	14		01015#06	G1MCM6-N1/4
	3/8	38.5	14.3		4.8	18		01015#07	G1MCM6-N3/8
	1/2	44.8	19.0		4.8	22		01015#08	G1MCM6-N1/2
8	1/8	34.9	9.5	16.7	4.8	15	17	01015#09	G1MCM8-N1/8
	1/4	39.5	14.3		6.5	15		01015#10	G1MCM8-N1/4
	3/8	40.0	14.3		6.5	18		01015#11	G1MCM8-N3/8
	1/2	46.3	19.0		6.5	22		01015#12	G1MCM8-N1/2
10	1/8	37.0	9.5	17.9	4.8	18	19	01015#13	G1MCM10-N1/8
	1/4	41.7	14.3		7.0	18		01015#14	G1MCM10-N1/4
	3/8	41.7	14.3		8.0	18		01015#15	G1MCM10-N3/8
	1/2	47.3	19.0		8.0	22		01015#16	G1MCM10-N1/2
	3/4	47.3	19.0		8.0	27		01015#17	G1MCM10-N3/4
12	1/4	43.6	14.3	22.8	7.0	22	22	01015#18	G1MCM12-N1/4
	3/8	43.6	14.3		9.5	22		01015#19	G1MCM12-N3/8
	1/2	49.2	19.0		9.5	22		01015#20	G1MCM12-N1/2
	3/4	50.7	19.0		9.5	27		01015#21	G1MCM12-N3/4
14	1/4	44.4	14.3	24.4	7.0	24	27	01015#22	G1MCM14-N1/4
	3/8	44.4	14.3		9.5	24		01015#23	G1MCM14-N3/8
	1/2	49.2	19.0		11.0	24		01015#24	G1MCM14-N1/2
15	1/2	49.2	19.0	24.4	12.0	24	27	01015#25	G1MCM15-N1/2
16	3/8	44.4	14.3	24.4	9.5	24	27	01015#26	G1MCM16-N3/8
	1/2	49.2	19.0		12.0	24		01015#27	G1MCM16-N1/2
	3/4	50.8	19.0		13.0	27		01015#28	G1MCM16-N3/4
18	1/2	53.4	19.0	26.9	12.0	27	30	01015#29	G1MCM18-N1/2
	3/4	53.4	19.0		15.0	27		01015#30	G1MCM18-N3/4
20	1/2	55.1	19.0	28.9	12.0	30	32	01015#31	G1MCM20-N1/2
	3/4	55.1	19.0		16.0	30		01015#32	G1MCM20-N3/4
22	3/4	55.3	19.0	29.1	16.0	30	32	01015#33	G1MCM22-N3/4
	1	60.6	24.0		18.5	36		01015#34	G1MCM22-N1
25	1/2	58.7	19.0	32.4	12.0	36	38	01015#35	G1MCM25-N1/2
	3/4	58.7	19.0		16.0	36		01015#36	G1MCM25-N3/4
	1	63.4	24.0		22.0	36		01015#37	G1MCM25-N1

MC-N

NPT外螺纹终端接头 (英制管)

NPT Male Connector (For fractional tube)

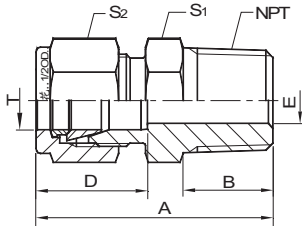
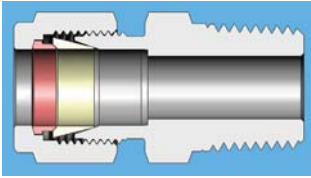

Tube O.D.								Product No.	Type
T	NPT	A	B	D	E	S1	S2	产品编号	型号
1/8	1/8	30.8	9.5	12.9	2.5	12	12	01016#01	G1MC1/8-N1/8
	1/4	35.9	14.3		2.5	14		01016#02	G1MC1/8-N1/4
	3/8	36.4	14.3		2.5	18		01016#03	G1MC1/8-N3/8
	1/2	42.5	19.0		2.5	22		01016#04	G1MC1/8-N1/2
3/16	1/8	32.2	9.5	14.6	3.0	12	12	01016#05	G1MC3/16-N1/8
	1/4	37.3	14.3		3.0	14		01016#06	G1MC3/16-N1/4
1/4	1/8	32.9	9.5	15.5	5.0	14	14	01016#07	G1MC1/4-N1/8
	1/4	38.0	14.3		5.0	14		01016#08	G1MC1/4-N1/4
	3/8	38.5	14.3		5.0	18		01016#09	G1MC1/4-N3/8
	1/2	44.8	19.0		5.0	22		01016#10	G1MC1/4-N1/2
	3/4	46.4	19.0		5.0	27		01016#11	G1MC1/4-N3/4
5/16	1/8	34.9	9.5	16.7	5.0	15	17	01016#12	G1MC5/16-N1/8
	1/4	39.4	14.3		6.5	15		01016#13	G1MC5/16-N1/4
	3/8	40.0	14.3		6.5	18		01016#14	G1MC5/16-N3/8
	1/2	46.3	19.0		6.5	22		01016#15	G1MC5/16-N1/2
3/8	1/8	36.1	9.5	17.9	5.0	17	18	01016#16	G1MC3/8-N1/8
	1/4	40.9	14.3		7.0	17		01016#17	G1MC3/8-N1/4
	3/8	40.9	14.3		7.0	18		01016#18	G1MC3/8-N3/8
	1/2	47.3	19.0		7.0	22		01016#19	G1MC3/8-N1/2
	3/4	48.8	19.0		7.0	27		01016#20	G1MC3/8-N3/4
1/2	1/8	39.0	9.5	22.8	5.0	22	22	01016#21	G1MC1/2-N1/8
	1/4	43.6	14.3		7.0	22		01016#22	G1MC1/2-N1/4
	3/8	43.6	14.3		9.0	22		01016#23	G1MC1/2-N3/8
	1/2	49.2	19.0		10.5	22		01016#24	G1MC1/2-N1/2
	3/4	50.7	19.0		10.5	27		01016#25	G1MC1/2-N3/4
	1	58.1	24.0		10.5	36		01016#26	G1MC1/2-N1
5/8	3/8	44.3	14.3	24.4	10.0	24	27	01016#27	G1MC5/8-N3/8
	1/2	49.2	19.0		12.0	24		01016#28	G1MC5/8-N1/2
	3/4	50.7	19.0		13.0	27		01016#29	G1MC5/8-N3/4
3/4	1/2	53.3	19.0	26.9	12.0	27	30	01016#30	G1MC3/4-N1/2
	3/4	53.3	19.0		16.0	27		01016#31	G1MC3/4-N3/4
	1	60.7	24.0		16.0	36		01016#32	G1MC3/4-N1
7/8	3/4	53.5	19.0	29.1	16.0	30	32	01016#33	G1MC7/8-N3/4
	1	60.9	24.0		18.5	36		01016#34	G1MC7/8-N1
1	1/2	58.7	19.0	32.5	12.0	36	38	01016#35	G1MC1-N1/2
	3/4	58.7	19.0		16.0	36		01016#36	G1MC1-N3/4
	1	63.5	24		22.0	36		01016#37	G1MC1-N1

MCM-R

外螺纹终端接头-BSPT螺纹 (米制管)

Male Connector-ISO BSP Taper Thread (R) (For metric tube)

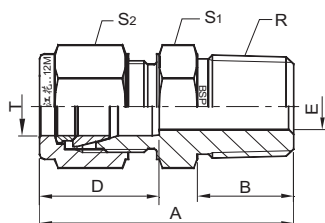
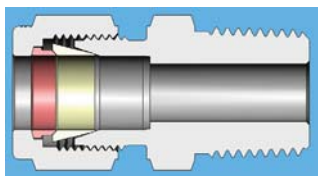

Tube O.D.	BSPT Thread	A	B	D	E	S1	S2	Product No.	Type
T	R							产品编号	型号
3	1/8	30.0	9.5	12.9	2.5	12	12	01017#01	G1MCM3-R1/8
	1/4	35.6	14.3		2.5	14		01017#02	G1MCM3-R1/4
4	1/8	32.1	9.5	14.5	2.5	12	12	01017#03	G1MCM4-R1/8
	1/4	37.2	14.3		2.5	14		01017#04	G1MCM4-R1/4
6	1/8	32.9	9.5	15.5	4.8	14	14	01017#05	G1MCM6-R1/8
	1/4	38.1	14.3		4.8	14		01017#06	G1MCM6-R1/4
	3/8	38.5	14.3		4.8	18		01017#07	G1MCM6-R3/8
	1/2	44.8	19.0		4.8	22		01017#08	G1MCM6-R1/2
8	1/8	34.9	9.5	16.7	4.8	15	17	01017#09	G1MCM8-R1/8
	1/4	39.5	14.3		6.5	15		01017#10	G1MCM8-R1/4
	3/8	40.0	14.3		6.5	18		01017#11	G1MCM8-R3/8
	1/2	46.3	19.0		6.5	22		01017#12	G1MCM8-R1/2
10	1/8	37.0	9.5	17.9	4.8	18	19	01017#13	G1MCM10-R1/8
	1/4	41.7	14.3		7.0	18		01017#14	G1MCM10-R1/4
	3/8	41.7	14.3		8.0	18		01017#15	G1MCM10-R3/8
	1/2	47.3	19.0		8.0	22		01017#16	G1MCM10-R1/2
12	1/4	43.6	14.3	22.8	7.0	22	22	01017#17	G1MCM12-R1/4
	3/8	43.6	14.3		9.5	22		01017#18	G1MCM12-R3/8
	1/2	49.2	19.0		9.5	22		01017#19	G1MCM12-R1/2
	3/4	50.7	19.0		9.5	27		01017#20	G1MCM12-R3/4
14	1/4	44.4	14.3	24.4	7.0	24	27	01017#21	G1MCM14-R1/4
	3/8	44.4	14.3		9.5	24		01017#22	G1MCM14-R3/8
	1/2	49.2	19.0		11.0	24		01017#23	G1MCM14-R1/2
15	1/2	49.0	19.0	24.4	12.0	24	27	01017#24	G1MCM15-R1/2
16	3/8	44.4	14.3	24.4	9.5	24	27	01017#25	G1MCM16-R3/8
	1/2	49.2	19.0		12.0	24		01017#26	G1MCM16-R1/2
	3/4	50.8	19.0		13.0	27		01017#27	G1MCM16-R3/4
18	1/2	53.4	19.0	26.9	12.0	27	30	01017#28	G1MCM18-R1/2
	3/4	53.4	19.0		15.0	27		01017#29	G1MCM18-R3/4
20	1/2	55.1	19.0	38.9	12.0	30	32	01017#30	G1MCM20-R1/2
	3/4	55.1	19.0		16.0	30		01017#31	G1MCM20-R3/4
22	3/4	55.3	19.0	29.1	16.0	30	32	01017#32	G1MCM22-R3/4
	1	60.6	24.0		18.5	36		01017#33	G1MCM22-R1
25	3/4	58.7	19.0	32.4	16.0	36	38	01017#34	G1MCM25-R3/4
	1	63.4	24.0		22.0	36		01017#35	G1MCM25-R1

MCR

BSP圆锥外螺纹(R)终端接头 (英制管)

BSP Taper (R) Male Connector (For fractional tube)

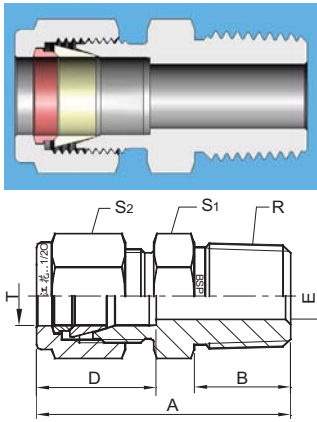

Tube O.D.	BSPT Thread	A	B	D	E	S1	S2	Product No.	Type
T	R							产品编号	型号
1/8	1/8	30.8	9.5	12.9	2.5	12	12	01018#01	G1MC1/8-R1/8
	1/4	35.9	14.3		2.5	14		01018#02	G1MC1/8-R1/4
1/4	1/8	32.9	9.5	15.5	5.0	14	14	01018#03	G1MC1/4-R1/8
	1/4	38.0	14.3		5.0	14		01018#04	G1MC1/4-R1/4
	3/8	38.5	14.3		5.0	18		01018#05	G1MC1/4-R3/8
	1/2	44.8	19.0		5.0	22		01018#06	G1MC1/4-R1/2
5/16	1/8	34.9	9.5	16.7	5.0	15	17	01018#07	G1MC5/16-R1/8
	1/4	39.4	14.3		6.5	15		01018#08	G1MC5/16-R1/4
3/8	1/8	36.1	9.5	17.9	5.0	17	18	01018#09	G1MC3/8-R1/8
	1/4	40.9	14.3		7.0	17		01018#10	G1MC3/8-R1/4
	3/8	40.9	14.3		7.0	18		01018#11	G1MC3/8-R3/8
	1/2	47.3	19.0		7.0	22		01018#12	G1MC3/8-R1/2
1/2	1/4	43.6	14.3	22.8	7.0	22	22	01018#13	G1MC1/2-R1/4
	3/8	43.6	14.3		9.0	22		01018#14	G1MC1/2-R3/8
	1/2	49.2	19.0		10.5	22		01018#15	G1MC1/2-R1/2
	3/4	50.7	19.0		10.5	27		01018#16	G1MC1/2-R3/4
3/4	3/4	53.3	19.0	26.9	16.0	27	30	01018#17	G1MC3/4-R3/4
1	1	63.5	24.0	32.5	22	36	38	01018#18	G1MC1-R1

MC-GA

外螺纹终端接头-BSPP(G)螺纹垫片密封 型式A (英制管)

Male Connector-BSPP(G) Thread Sealing with Gasket (Form A)

For fractional tube

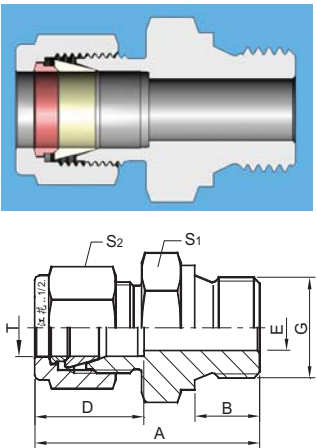

Tube O.D.	BSPP Thread	A	B	D	E	S1	S2	Product No.	Type
T	G							产品编号	型号
1/8	1/8	30.4	8.0	12.9	2.5	14	12	01019#01	G1MC1/8-GA1/8
	1/4	35.4	12.0		2.5	19		01019#02	G1MC1/8-GA1/4
1/4	1/8	32.5	8.0	15.5	5.0	14	14	01019#03	G1MC1/4-GA1/8
	1/4	37.5	12.0		5.0	19		01019#04	G1MC1/4-GA1/4
	3/8	39.0	12.0		5.0	22		01019#05	G1MC1/4-GA3/8
	1/2	45.0	14.0		5.0	27		01019#06	G1MC1/4-GA1/2
3/8	1/4	40.4	12.0	17.9	7.0	19	18	01019#07	G1MC3/8-GA1/4
	3/8	41.4	12.0		7.0	22		01019#08	G1MC3/8-GA3/8
	1/2	47.4	14.0		7.0	27		01019#09	G1MC3/8-GA1/2
1/2	1/4	42.8	12.0	22.8	7.0	22	22	01019#10	G1MC1/2-GA1/4
	3/8	43.3	12.0		9.0	22		01019#11	G1MC1/2-GA3/8
	1/2	49.3	14.0		10.5	27		01019#12	G1MC1/2-GA1/2
3/4	1/2	51.9	14.0	26.9	12.0	27	30	01019#13	G1MC3/4-GA1/2
	3/4	55.4	16.0		16.0	32		01019#14	G1MC3/4-GA3/4
1	3/4	58.4	16.0	32.5	18.0	36	38	01019#15	G1MC1-GA3/4
	1	61.4	18.0		22.0	41		01019#16	G1MC1-GA1

注: BSPP圆柱管螺纹终端(型式A)常规采用带弹性体的组合垫片密封,金属平垫也可适用。

NOTE: BSPP parallel thread ends (Form A) are typically used with a gasket having a bonded elastomer seal. The flat metal gaskets may also be used.

MCM-GA

外螺纹终端接头-BSP(G)螺纹垫片密封, 型式A (米制管)

Male Connector-BSP Thread (G) Sealing with Gasket (Form A)

For metric tube

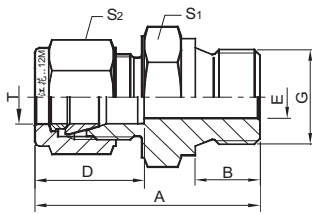
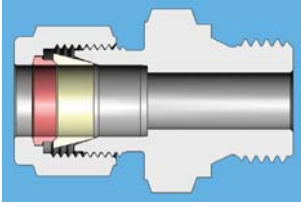

Tube O.D.	BSPP Thread	Dimensions						Product No.	Type
T	G	A	B	D	E	S1	S2	产品编号	型号
3	1/8	30.4	8.0	12.9	2.5	14	12	01020#01	G1MCM3-GA1/8
	1/4	35.4	12.0		2.5	19		01020#02	G1MCM3-GA1/4
4	1/8	31.5	8.0	14.5	2.5	14	12	01020#03	G1MCM4-GA1/8
	1/4	32.5	8.0	15.5	4.8	14	14	01020#04	G1MCM6-GA1/8
6	1/4	37.5	12.0		4.8	19		01020#05	G1MCM6-GA1/4
	3/8	39.0	12.0		4.8	22		01020#06	G1MCM6-GA3/8
	1/2	45.0	14.0		4.8	27		01020#07	G1MCM6-GA1/2
8	1/8	33.7	8.0	16.7	4.8	15	17	01020#08	G1MCM8-GA1/8
	1/4	39.2	12.0		6.5	19		01020#09	G1MCM8-GA1/4
	3/8	40.7	12.0		6.5	22		01020#10	G1MCM8-GA3/8
	1/2	46.2	14.0		6.5	27		01020#11	G1MCM8-GA1/2
10	1/4	40.4	12.0	17.9	7.0	19	19	01020#12	G1MCM10-GA1/4
	3/8	41.4	12.0		8.0	22		01020#13	G1MCM10-GA3/8
	1/2	47.4	14.0		8.0	27		01020#14	G1MCM10-GA1/2
12	1/4	42.8	12.0	22.8	7.0	22	22	01020#15	G1MCM12-GA1/4
	3/8	43.3	12.0		9.5	22		01020#16	G1MCM12-GA3/8
	1/2	49.3	14.0		9.5	27		01020#17	G1MCM12-GA1/2
	3/4	52.8	16.0		9.5	32		01020#18	G1MCM12-GA3/4
16	3/8	44.3	12.0	24.4	9.5	24	27	01020#19	G1MCM16-GA3/8
	1/2	49.3	14.0		12.0	27		01020#20	G1MCM16-GA1/2
18	1/2	51.9	14.0	26.9	12.0	27	30	01020#21	G1MCM18-GA1/2
	3/4	55.4	16.0		15.0	32		01020#22	G1MCM18-GA3/4
20	1/2	53.4	14.0	28.9	12.0	30	32	01020#23	G1MCM20-GA1/2
	3/4	55.4	16.0		16.0	32		01020#24	G1MCM20-GA3/4
22	3/4	55.6	16.0	29.1	16.0	32	32	01020#25	G1MCM22-GA3/4
	1	58.1	18.0		18.0	41		01020#26	G1MCM22-GA1
25	3/4	58.4	16.0	32.4	18.0	36	38	01020#27	G1MCM25-GA3/4
	1	61.4	18.0		22.0	41		01020#28	G1MCM25-GA1

注: BSP(G)圆柱管螺纹终端(型式A)常规采用带弹性体的组合垫片密封,金属平垫也可适用。

NOTE: BSP parallel thread ends (Form A) are typically used with a gasket having a bonded elastomer seal. The flat metal gaskets may also be used.

MCM-GB

外螺纹终端接头-BSP(G)螺纹唇边密封, 型式B (米制管)

Male Connector-BSP Thread (G) Sealing with Cutting Face (Form B)

For metric tube

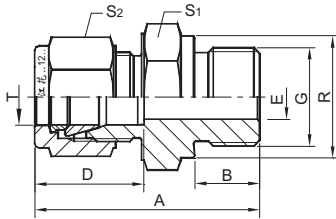
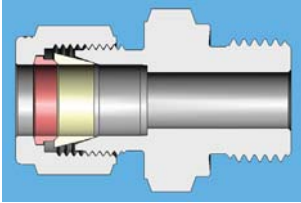

Tube O.D.	BSPP Thread	A	B	D	E	S1	S2	Product No.	Type
T	G							产品编号	型号
3	1/8	30.4	8.0	12.9	2.5	14	12	01021#01	G1MCM3-GB1/8
	1/4	35.4	12.0		2.5	19		01021#02	G1MCM3-GB1/4
4	1/8	31.5	8.0	14.5	2.5	14	12	01021#03	G1MCM4-GB1/8
6	1/8	32.5	8.0	15.5	4.8	14	14	01021#04	G1MCM6-GB1/8
	1/4	37.5	12.0		4.8	19		01021#05	G1MCM6-GB1/4
	3/8	39.0	12.0		4.8	22		01021#06	G1MCM6-GB3/8
	1/2	45.0	14.0		4.8	27		01021#07	G1MCM6-GB1/2
8	1/8	33.7	8.0	16.7	4.8	15	17	01021#08	G1MCM8-GB1/8
	1/4	39.2	12.0		6.5	19		01021#09	G1MCM8-GB1/4
	3/8	40.7	12.0		6.5	22		01021#10	G1MCM8-GB3/8
	1/2	46.2	14.0		6.5	27		01021#11	G1MCM8-GB1/2
10	1/4	40.4	12.0	17.9	7.0	19	19	01021#12	G1MCM10-GB1/4
	3/8	41.4	12.0		8.0	22		01021#13	G1MCM10-GB3/8
	1/2	47.4	14.0		8.0	27		01021#14	G1MCM10-GB1/2
12	1/4	42.8	12.0	22.8	7.0	22	22	01021#15	G1MCM12-GB1/4
	3/8	43.3	12.0		9.5	22		01021#16	G1MCM12-GB3/8
	1/2	49.3	14.0		9.5	27		01021#17	G1MCM12-GB1/2
	3/4	52.8	16.0		9.5	32		01021#18	G1MCM12-GB3/4
16	3/8	44.3	12.0	24.4	9.5	24	27	01021#19	G1MCM16-GB3/8
	1/2	49.3	14.0		12.0	27		01021#20	G1MCM16-GB1/2
18	1/2	51.9	14.0	26.9	12.0	27	30	01021#21	G1MCM18-GB1/2
	3/4	55.4	16.0		15.0	32		01021#22	G1MCM18-GB3/4
20	1/2	53.4	14.0	28.9	12.0	30	32	01021#23	G1MCM20-GB1/2
	3/4	55.4	16.0		16.0	32		01021#24	G1MCM20-GB3/4
22	3/4	55.6	16.0	29.1	16.0	32	32	01021#25	G1MCM22-GB3/4
	1	58.1	18.0		18.0	41		01021#26	G1MCM22-GB1
25	3/4	58.4	19.0	32.4	18.0	36	38	01021#27	G1MCM25-GB3/4
	1	61.4	24.0		22.0	41		01021#28	G1MCM25-GB1

注: BSPP圆柱管螺纹终端(型式B)常规采用金属平垫密封。

NOTE: BSPP parallel thread ends (Form B) are typically used with a flat gasket to seal.

MC-GB

外螺纹终端接头-BSPP(G)螺纹唇边密封, 型式B (英制管)

Male Connector-BSPP Thread (G) Sealing with Cutting Face (Form B)

For fractional tube

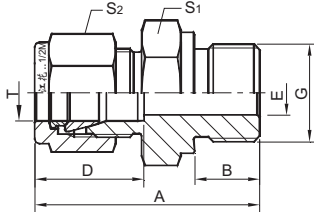
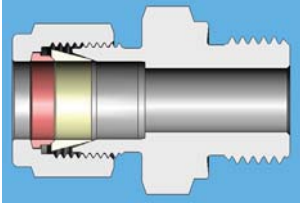

Tube O.D. T	BSPP Thread G	A	B	D	E	S1	S2	Product No. 产品编号	Type 型号
1/8	1/8	30.4	8.0	12.9	2.5	14	12	01022#01	G1MC1/8-GB1/8
	1/4	35.4	12.0		2.5	19		01022#02	G1MC1/8-GB1/4
1/4	1/8	32.5	8.0	15.5	5.0	14	14	01022#03	G1MC1/4-GB1/8
	1/4	37.5	12.0		5.0	19		01022#04	G1MC1/4-GB1/4
	3/8	39.0	12.0		5.0	22		01022#05	G1MC1/4-GB3/8
	1/2	45.0	14.0		5.0	27		01022#06	G1MC1/4-GB1/2
3/8	1/4	40.4	12.0	17.9	7.0	19	18	01022#07	G1MC3/8-GB1/4
	3/8	41.4	12.0		7.0	22		01022#08	G1MC3/8-GB3/8
	1/2	47.4	14.0		7.0	27		01022#09	G1MC3/8-GB1/2
1/2	1/4	42.8	12.0	22.8	7.0	22	22	01022#10	G1MC1/2-GB1/4
	3/8	43.3	12.0		9.0	22		01022#11	G1MC1/2-GB3/8
	1/2	49.3	14.0		10.5	27		01022#12	G1MC1/2-GB1/2
3/4	1/2	51.9	14.0	26.9	12.0	27	30	01022#13	G1MC3/4-GB1/2
	3/4	55.4	16.0		16.0	32		01022#14	G1MC3/4-GB3/4
1	3/4	58.4	16.0	32.5	18.0	36	38	01022#15	G1MC1-GB3/4
	1	61.4	18.0		22.0	41		01022#16	G1MC1-GB1

注: BSPP圆柱管螺纹终端(型式B)常规采用金属平垫密封。

NOTE: BSPP parallel thread ends (Form B) are typically used with a flat gasket to seal.

MC-GED

外螺纹终端接头-BSPP(G)螺纹ED弹性密封

Male Connector-BSPP Thread (G) with ED Seal

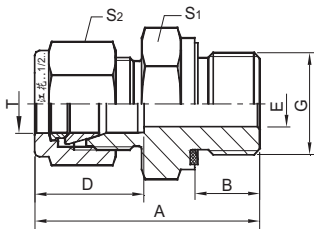
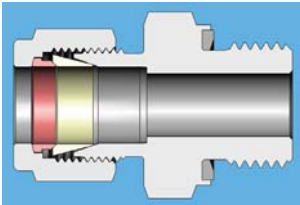

Tube O.D. T	BSPP Thread G	A	B	D	E	S1	S2	Product No. 产品编号	Type 型号	
英制管 For fractional tube										
1/4	1/4	37.5	12.0	15.5	5.0	19	14	01023#01	G1MC1/4-G1/4ED	
	1/2	45.0	14.0		5.0	27		01023#02	G1MC1/4-G1/2ED	
3/8	3/8	41.5	12.0	17.9	7.0	22	18	01023#03	G1MC3/8-G3/8ED	
	1/2	1/4	42.8	12.0	22.8	7.0	22	22	01023#04	G1MC1/2-G1/4ED
		3/8	43.3	12.0		9.0	22		01023#05	G1MC1/2-G3/8ED
	1/2	49.3	14.0		10.5	27		01023#06	G1MC1/2-G1/2ED	
3/4	3/4	55.5	16.0	26.9	16.0	32	30	01023#07	G1MC3/4-G3/4ED	
米制管 For metric tube										
6	1/4	37.5	12.0	15.5	4.8	19	14	01024#01	G1MCM6-G1/4ED	
	3/8	39.0	12.0		4.8	22		01024#02	G1MCM6-G3/8ED	
	1/2	45.0	14.0		4.8	27		01024#03	G1MCM6-G1/2ED	
10	1/4	40.4	12.0	17.9	7.0	19	19	01024#04	G1MCM10-G1/4ED	
	3/8	41.4	12.0		8.0	22		01024#05	G1MCM10-G3/8ED	
	1/2	47.4	14.0		8.0	27		01024#06	G1MCM10-G1/2ED	
12	1/4	42.8	12.0	22.8	7.0	22	22	01024#07	G1MCM12-G1/4ED	
	3/8	43.3	12.0		9.5	22		01024#08	G1MCM12-G3/8ED	
	1/2	49.3	14.0		9.5	27		01024#09	G1MCM12-G1/2ED	

注: 常规ED弹性密封圈为丁腈胶, 使用温度-25~90℃, 如需要可配用氟橡胶密封圈, 使用温度-25~120℃.

NOTE: ED fittings are supplied with sealing washers in NBR as standard, suitable for temperatures of between -25°C and +90°C. Viton seals are available upon request which are suitable for temperatures of between -25°C and +120°C.

MEM-N

NPT外螺纹弯通终端接头 (米制管)

NPT Male Elbow (For metric tube)

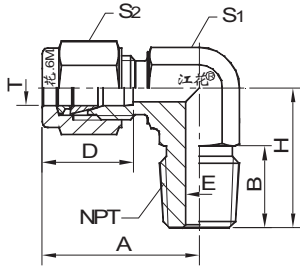
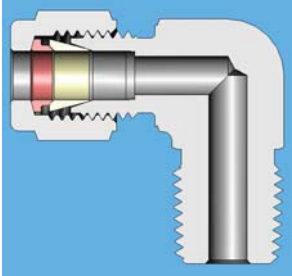

Tube O.D.	T	NPT	A	D	H	B	E	S1	S2	Product	Type	
										No.	型号	
											产品编号	型号
3		1/8	23.9	12.9	17.8	9.7	2.5	11.1	12	01025#01	G1MEM3-N1/8	
		1/4	24.9		23.4	14.2		12.7		01025#02	G1MEM3-N1/4	
4		1/8	26.3	14.5	18.8	9.7	2.5	12.7	12	01025#03	G1MEM4-N1/8	
		1/4	27.1		25.4	14.2		12.7		01025#04	G1MEM4-N1/4	
6		1/8	27.1	15.5	18.8	9.7	4.8	12.7	14	01025#05	G1MEM6-N1/8	
		1/4	27.1		23.4	14.2		12.7		01025#06	G1MEM6-N1/4	
		3/8	29.9		26.2	14.2		17.5		01025#07	G1MEM6-N3/8	
		1/2	31.9		33.0	19.0		20.6		01025#08	G1MEM6-N1/2	
8		1/8	29.5	16.7	19.8	9.7	4.8	14.3	17	01025#09	G1MEM8-N1/8	
		1/4	29.5		24.4	14.2	6.5	14.3		01025#10	G1MEM8-N1/4	
		3/8	31.3		26.2	14.2	6.5	17.5		01025#11	G1MEM8-N3/8	
		1/2	33.4		33.0	19.0	6.5	20.6		01025#12	G1MEM8-N1/2	
10		1/8	32.3	17.9	21.6	9.7	4.8	17.5	19	01025#13	G1MEM10-N1/8	
		1/4	32.3		26.2	14.2	7.0	17.5		01025#14	G1MEM10-N1/4	
		3/8	32.3		26.2	14.2	8.0	17.5		01025#15	G1MEM10-N3/8	
		1/2	34.3		33.0	19.0	8.0	20.6		01025#16	G1MEM10-N1/2	
12		1/4	36.2	22.8	28.2	14.2	7.0	20.6	22	01025#17	G1MEM12-N1/4	
		3/8	36.2		28.2	14.2	9.5	20.6		01025#18	G1MEM12-N3/8	
		1/2	36.2		33.0	19.0	9.5	20.6		01025#19	G1MEM12-N1/2	
		3/4	40.0		36.8	19.0	9.5	27		01025#20	G1MEM12-N3/4	
15	1/2	38.2	24.4	35.1	19.0	12.0	23.8	27	01025#21	G1MEM15-N1/2		
16		3/8	38.2	24.4	30.2	14.2	9.5	23.8	27	01025#22	G1MEM16-N3/8	
		1/2	38.2		35.1	19.0	12.0	23.8		01025#23	G1MEM16-N1/2	
		3/4	40.0		36.8	19.0	13.0	27		01025#24	G1MEM16-N3/4	
18		1/2	42.6	26.9	36.8	19.0	12.0	27	30	01025#25	G1MEM18-N1/2	
		3/4	42.6		36.8	19.0	15.0	27		01025#26	G1MEM18-N3/4	
20		1/2	47.4	28.9	41.7	19.0	12.0	35	32	01025#27	G1MEM20-N1/2	
		3/4	47.4		41.7	19.0	16.0	35		01025#28	G1MEM20-N3/4	
22		3/4	47.6	29.1	41.7	19.0	16.0	35	32	01025#29	G1MEM22-N3/4	
		1	47.6		46.7	24.0	18.5	35		01025#30	G1MEM22-N1	
25		3/4	50.2	32.4	41.7	19.0	16.0	35	38	01025#31	G1MEM25-N3/4	
		1	50.2		46.7	24.0	22.0	35		01025#32	G1MEM25-N1	

ME-N

NPT外螺纹弯通终端接头 (英制管)

NPT Male Elbow (For fractional tube)

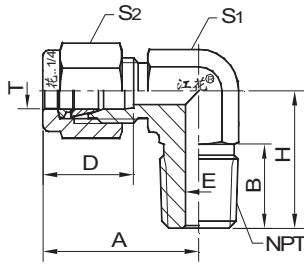
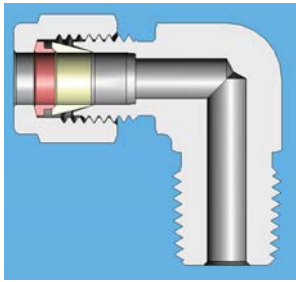

Tube O.D.									Product No.	Type
T	NPT	A	D	H	B	E	S1	S2	产品编号	型号
1/8	1/8	23.9	12.9	17.8	9.5	2.5	11.1	12	01026#01	G1ME1/8-N1/8
	1/4	25.2		23.4	14.3	2.5	12.7		01026#02	G1ME1/8-N1/4
3/16	1/8	26.4	14.6	18.8	9.5	3.0	12.7	12	01026#03	G1ME3/16-N1/8
	1/4	26.4		23.4	14.3	3.0	12.7		01026#04	G1ME3/16-N1/4
1/4	1/8	26.6	15.5	18.8	9.5	5.0	12.7	14	01026#05	G1ME1/4-N1/8
	1/4	27.3		23.4	14.3	5.0	12.7		01026#06	G1ME1/4-N1/4
	3/8	29.9		26.2	14.3	5.0	17.5		01026#07	G1ME1/4-N3/8
	1/2	32.1		33.0	19.0	5.0	20.6		01026#08	G1ME1/4-N1/2
5/16	1/8	29.5	16.7	19.8	9.5	5.0	14.3	17	01026#09	G1ME5/16-N1/8
	1/4	29.5		24.4	14.3	6.5	14.3		01026#10	G1ME5/16-N1/4
	3/8	31.3		26.2	14.3	6.5	17.5		01026#11	G1ME5/16-N3/8
3/8	1/8	31.5	17.9	20.8	9.5	5.0	15.9	18	01026#12	G1ME3/8-N1/8
	1/4	31.5		25.4	14.3	7.0	15.9		01026#13	G1ME3/8-N1/4
	3/8	33.0		26.2	14.3	7.0	17.5		01026#14	G1ME3/8-N3/8
	1/2	34.3		33.0	19.0	7.0	20.6		01026#15	G1ME3/8-N1/2
	3/4	38.1		36.8	19.0	7.0	27		01026#16	G1ME3/8-N3/4
1/2	1/4	36.2	22.8	28.2	14.3	7.0	20.6	22	01026#17	G1ME1/2-N1/4
	3/8	36.2		28.2	14.3	9.0	20.6		01026#18	G1ME1/2-N3/8
	1/2	36.2		33.0	19.0	10.5	20.6		01026#19	G1ME1/2-N1/2
	3/4	40.0		36.8	19.0	10.5	27		01026#20	G1ME1/2-N3/4
5/8	3/8	38.3	24.4	30.2	14.3	10.0	23.8	27	01026#21	G1ME5/8-N3/8
	1/2	38.3		35.1	19.0	12.0	23.8		01026#22	G1ME5/8-N1/2
	3/4	40.0		36.8	19.0	13.0	27		01026#23	G1ME5/8-N3/4
3/4	1/2	42.6	26.9	36.8	19.0	12.0	27	30	01026#24	G1ME3/4-N1/2
	3/4	42.6		36.8	19.0	16.0	27		01026#25	G1ME3/4-N3/4
7/8	3/4	47.6	29.1	41.7	19.0	16.0	35	32	01026#26	G1ME7/8-N3/4
1	3/4	50.3	32.5	41.7	19.0	16.0	35	38	01026#27	G1ME1-N3/4
	1	50.3		46.5	24	22	35		01026#28	G1ME1-N1

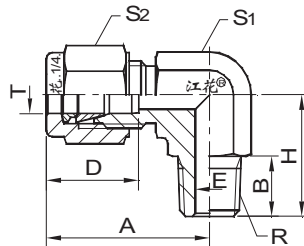
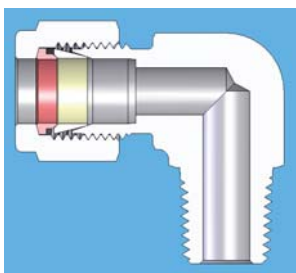

ME-R

BSPT外螺纹弯通终端接头 (英制管)

BSP Taper (R) Male Elbow (For fractional tube)

Tube O.D.									Product No.	Type
T	R	A	D	H	B	E	S1	S2	产品编号	型号
1/4	1/8	26.6	15.5	18.8	9.5	5.0	12.7	14	01027#01	G1ME1/4-R1/8
	1/4	27.3		23.4	14.3	5.0	12.7		01027#02	G1ME1/4-R1/4
	3/8	29.9		26.2	14.3	5.0	17.5		01027#03	G1ME1/4-R3/8
	1/2	32.1		33.0	19.0	5.0	20.6		01027#04	G1ME1/4-R1/2
5/16	1/4	29.5	16.7	24.4	14.3	6.5	14.3	17	01027#05	G1ME5/16-R1/4
3/8	1/4	31.5	17.9	25.4	14.3	7.0	15.9	18	01027#06	G1ME3/8-R1/4
	3/8	33.0		26.2	14.3	7.0	17.5		01027#07	G1ME3/8-R3/8
1/2	3/8	36.2	22.8	28.2	14.3	9.0	20.6	22	01027#08	G1ME1/2-R3/8
	1/2	36.2		33.0	19.0	10.5	20.6		01027#09	G1ME1/2-R1/2

MEM-R

BSPT外螺纹弯通终端接头 (米制管)

BSP Taper (R) Male Elbow (For metric tube)

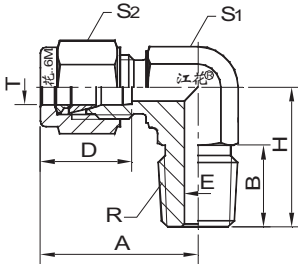
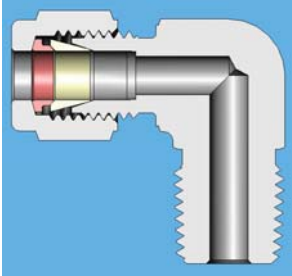

Tube O.D.	BSPT T	R	A	D	H	B	E	S1	S2	Product	Type
										No.	型号
3	1/8	23.9	12.9	17.8	9.7	2.5	11.1	12	01028#01	G1MEM3-R1/8	
		24.9		23.4	14.2	12.7			01028#02	G1MEM3-R1/4	
4	1/8	26.3	14.5	18.8	9.7	2.5	12.7	12	01028#03	G1MEM4-R1/8	
		27.1		25.4	14.2	12.7			01028#04	G1MEM4-R1/4	
6	1/8	27.1	15.5	18.8	9.7	4.8	12.7	14	01028#05	G1MEM6-R1/8	
		27.1		23.4	14.2	12.7			01028#06	G1MEM6-R1/4	
	3/8	29.9		26.2	14.2	17.5			01028#07	G1MEM6-R3/8	
		31.9		33.0	19.0	20.6			01028#08	G1MEM6-R1/2	
8	1/8	29.5	16.7	19.8	9.7	4.8	14.3	17	01028#09	G1MEM8-R1/8	
		29.5		24.4	14.2	6.5	14.3		01028#10	G1MEM8-R1/4	
	3/8	31.3		26.2	14.2	6.5	17.5		01028#11	G1MEM8-R3/8	
		33.4		33.0	19.0	6.5	20.6		01028#12	G1MEM8-R1/2	
10	1/8	32.3	17.9	21.6	9.7	4.8	17.5	19	01028#13	G1MEM10-R1/8	
		32.3		26.2	14.2	7.0	17.5		01028#14	G1MEM10-R1/4	
	3/8	32.3		26.2	14.2	8.0	17.5		01028#15	G1MEM10-R3/8	
		34.3		33.0	19.0	8.0	20.6		01028#16	G1MEM10-R1/2	
12	1/4	36.2	22.8	28.2	14.2	7.0	20.6	22	01028#17	G1MEM12-R1/4	
		36.2		28.2	14.2	9.5	20.6		01028#18	G1MEM12-R3/8	
	1/2	36.2		33.0	19.0	9.5	20.6		01028#19	G1MEM12-R1/2	
		40.0		36.8	19.0	9.5	27		01028#20	G1MEM12-R3/4	
15	1/2	38.2	24.4	35.1	19.0	12.0	23.8	27	01028#21	G1MEM15-R1/2	
16	3/8	38.2	24.4	30.2	14.2	9.5	23.8	27	01028#22	G1MEM16-R3/8	
		38.2		35.1	19.0	12.0	23.8		01028#23	G1MEM16-R1/2	
	3/4	40.0		36.8	19.0	13.0	27		01028#24	G1MEM16-R3/4	
18	1/2	42.6	26.9	36.8	19.0	12.0	27	30	01028#25	G1MEM18-R1/2	
		42.6		36.8	19.0	15.0	27		01028#26	G1MEM18-R3/4	
20	1/2	47.4	28.9	41.7	19.0	12.0	35	32	01028#27	G1MEM20-R1/2	
		47.4		41.7	19.0	16.0	35		01028#28	G1MEM20-R3/4	
22	3/4	47.6	29.1	41.7	19.0	16.0	35	32	01028#29	G1MEM22-R3/4	
		47.6		46.7	24.0	18.5	35		01028#30	G1MEM22-R1	
25	3/4	50.2	32.4	41.7	19.0	16.0	35	38	01028#31	G1MEM25-R3/4	
		50.2		46.7	24.0	22.0	35		01028#32	G1MEM25-R1	

MRTM

NPT外螺纹直路三通终端接头 (米制管)

NPT Male Run Tee (For metric tube)

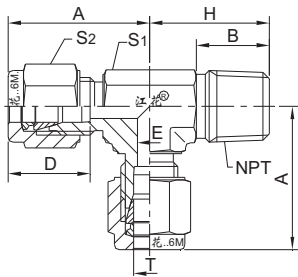
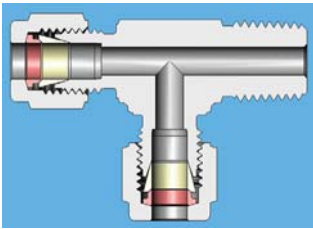

Tube O.D.									Product No.	Type
T	NPT	A	D	H	B	E	S1	S2	产品编号	型号
6	1/8	27.1	15.5	18.8	9.7	4.8	12.7	14	01029#01	G1MRTM6-N1/8
	1/4	27.1		23.4	14.2		12.7		01029#02	G1MRTM6-N1/4
8	1/8	29.5	16.7	20.8	9.7	4.8	14.3	17	01029#03	G1MRTM8-N1/8
	1/4	29.5		25.4	14.2	6.5	14.3		01029#04	G1MRTM8-N1/4
10	1/4	32.3	17.9	28.2	14.2	7.0	17.5	19	01029#05	G1MRTM10-N1/4
	1/2	34.3		33.0	19.0	8.0	20.6		01029#06	G1MRTM10-N1/2
12	1/4	36.2	22.8	28.2	14.2	7.0	20.6	22	01029#07	G1MRTM12-N1/4
	3/8	36.2		28.2	14.2	9.5	20.6		01029#08	G1MRTM12-N3/8
	1/2	36.2		33.0	19.0	9.5	20.6		01029#09	G1MRTM12-N1/2
16	1/2	38.2	24.4	35.8	19.0	12.0	23.8	27	01029#10	G1MRTM16-N1/2

MRT

NPT外螺纹直路三通终端接头 (英制管)

NPT Male Run Tee (For fractional tube)

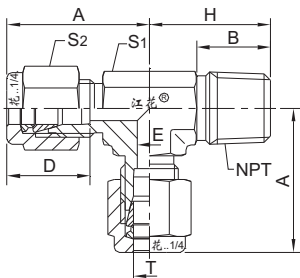
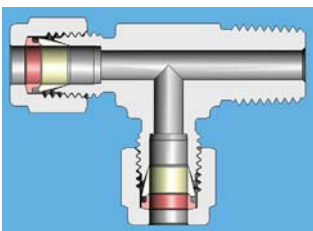

Tube O.D.									Product No.	Type
T	NPT	A	D	H	B	E	S1	S2	产品编号	型号
1/8	1/8	23.9	12.9	18.0	9.5	2.5	11.1	12	01030#01	G1MRT1/8-N1/8
	1/4	25.2		25.4	14.2	2.5	12.7		01030#02	G1MRT1/8-N1/4
3/16	1/8	26.4	14.6	18.8	9.7	3.0	12.7	12	01030#03	G1MRT3/16-N1/8
1/4	1/8	26.6	15.5	18.8	14.2	5.0	12.7	14	01030#04	G1MRT1/4-N1/8
	1/4	27.3		25.4	14.2	5.0	12.7		01030#05	G1MRT1/4-N1/4
5/16	1/8	29.5	16.7	20.8	9.7	5.0	14.3	17	01030#06	G1MRT5/16-N1/8
	1/4	29.5		25.7	14.2	6.5	14.3		01030#07	G1MRT5/16-N1/4
3/8	1/4	31.5	17.9	25.7	14.2	7.0	15.9	18	01030#08	G1MRT3/8-N1/4
	3/8	33.0		28.4	14.2	7.0	17.5		01030#09	G1MRT3/8-N3/8
1/2	3/8	36.2	22.8	28.2	14.2	9.0	20.6	22	01030#10	G1MRT1/2-N3/8
	1/2	36.2		33.3	19.0	10.5	20.6		01030#11	G1MRT1/2-N1/2
5/8	1/2	38.3	24.4	35.1	19.0	12.0	23.8	27	01030#12	G1MRT5/8-N1/2
3/4	3/4	42.6	26.9	38.1	19.0	16.0	27	30	01030#13	G1MRT3/4-N3/4
7/8	3/4	47.6	29.1	38.1	19.0	16.0	35	32	01030#14	G1MRT7/8-N3/4
1	3/4	50.3	32.5	42.2	19.0	16.0	35	38	01030#15	G1MRT1-N3/4
	1	50.3		46.5	24.0	22.0	35		01030#16	G1MRT1-N1

MBTM

NPT外螺纹分支三通终端接头 (米制管)

NPT Male Branch Tee (For metric tube)

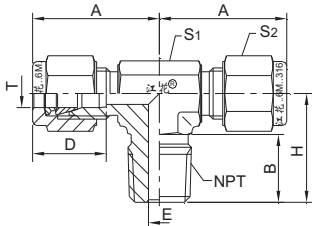
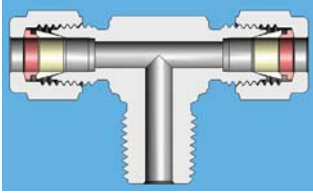

Tube O.D.									Product No.	Type
T	NPT	A	D	H	B	E	S1	S2	产品编号	型号
6	1/8	27.1	15.5	18.8	9.7	4.8	12.7	14	01031#01	G1MBTM6-N1/8
	1/4	27.1		23.4	14.2		12.7		01031#02	G1MBTM6-N1/4
8	1/8	29.5	16.7	20.8	9.7	4.8	14.3	17	01031#03	G1MBTM8-N1/8
	1/4	29.5		25.4	14.2	6.5	14.3		01031#04	G1MBTM8-N1/4
10	1/4	32.3	17.9	28.2	14.2	7.0	17.5	19	01031#05	G1MBTM10-N1/4
	1/2	34.3		33.0	19.0	8.0	20.6		01031#06	G1MBTM10-N1/2
12	1/4	36.2	22.8	28.2	14.2	7.0	20.6	22	01031#07	G1MBTM12-N1/4
	3/8	36.2		28.2	14.2	9.5	20.6		01031#08	G1MBTM12-N3/8
	1/2	36.2		33.0	19.0	9.5	20.6		01031#09	G1MBTM12-N1/2
16	1/2	38.2	24.4	35.8	19.0	12.0	23.8	27	01031#10	G1MBTM16-N1/2

MBT

NPT外螺纹分支三通终端接头 (英制管)

NPT Male Branch Tee (For fractional tube)

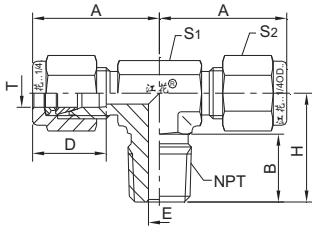
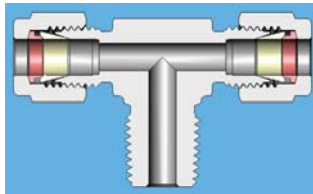

Tube O.D.									Product No.	Type
T	NPT	A	D	H	B	E	S1	S2	产品编号	型号
1/8	1/8	23.9	12.9	18.0	9.5	2.5	11.1	12	01032#01	G1MBT1/8-N1/8
	1/4	25.2		25.4	14.2	2.5	12.7		01032#02	G1MBT1/8-N1/4
3/16	1/8	26.4	14.6	18.8	9.7	3.0	12.7	12	01032#03	G1MBT3/16-N1/8
1/4	1/8	26.6	15.5	18.8	14.2	5.0	12.7	14	01032#04	G1MBT1/4-N1/8
	1/4	27.3		25.4	14.2	5.0	12.7		01032#05	G1MBT1/4-N1/4
5/16	1/8	29.5	16.7	20.8	9.7	5.0	14.3	17	01032#06	G1MBT5/16-N1/8
	1/4	29.5		25.7	14.2	6.5	14.3		01032#07	G1MBT5/16-N1/4
3/8	1/4	31.5	17.9	25.7	14.2	7.0	15.9	18	01032#08	G1MBT3/8-N1/4
	3/8	33.0		28.4	14.2	7.0	17.5		01032#09	G1MBT3/8-N3/8
1/2	3/8	36.2	22.8	28.2	14.2	9.0	20.6	22	01032#10	G1MBT1/2-N3/8
	1/2	36.2		33.3	19.0	10.5	20.6		01032#11	G1MBT1/2-N1/2
5/8	1/2	38.3	24.4	35.1	19.0	12.0	23.8	27	01032#12	G1MBT5/8-N1/2
3/4	3/4	42.6	26.9	38.1	19.0	16.0	27	30	01032#13	G1MBT3/4-N3/4
7/8	3/4	47.6	29.1	38.1	19.0	16.0	35	32	01032#14	G1MBT7/8-N3/4
1	3/4	50.3	32.5	42.2	19.0	16.0	35	38	01032#15	G1MBT1-N3/4
	1	50.3		46.5	24	22	35		01032#16	G1MBT1-N1

AME-G

可调向外螺纹弯通终端接头-BSPB螺纹

Adjustable Male Elbow - BSPB Thread

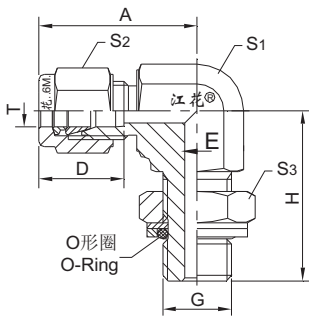
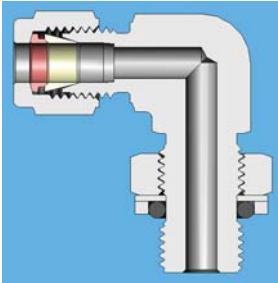

Tube O.D. T	ISO BSPB G	A	D	H	E	S1	S2	Product No. 产品编号	Type 型号
米制管 For metric tube									
6	1/8	27.1	15.5	32.0	4.0	12.7	14	01033#01	G1AMEM6-G1/8
	1/4	29.0		32.5	4.8	14.3		01033#02	G1AMEM6-G1/4
8	1/8	29.5	16.7	32.0	4.0	14.3	17	01033#03	G1AMEM8-G1/8
	1/4	29.5		32.5	6.0	14.3		01033#04	G1AMEM8-G1/4
10	1/4	34.3	17.9	32.5	6.0	20.6	19	01033#05	G1AMEM10-G1/4
	3/8	34.3		37.0	8.0	20.6		01033#06	G1AMEM10-G3/8
12	1/4	36.2	22.8	35.0	6.0	20.6	22	01033#07	G1AMEM12-G1/4
	3/8	36.2		37.0	8.0	20.6		01033#08	G1AMEM12-G3/8
	1/2	38.2		43.0	9.5	27		01033#09	G1AMEM12-G1/2
	3/4	40.0		48.0	9.5	27		01033#10	G1AMEM12-G3/4
英制管 For fractional tube									
1/4	1/8	26.6	15.5	18.8	4.0	12.7	14	01034#01	G1AME1/4-G1/8
	1/4	27.3		23.4	4.8	14.3		01034#02	G1AME1/4-G1/4
3/8	1/4	31.5	17.9	25.4	6.0	15.9	18	01034#03	G1AME3/8-G1/4
	3/8	34.8		26.2	7.0	20.6		01034#04	G1AME3/8-G3/8
1/2	1/4	36.2	22.8	28.2	6.0	20.6	22	01034#05	G1AME1/2-G1/4
	3/8	36.2		28.2	8.0	20.6		01034#06	G1AME1/2-G3/8
	1/2	36.2		33.0	10.5	23.8		01034#07	G1AME1/2-G1/2
5/8	1/2	38.3	24.4	35.1	12.0	23.8	27	01034#08	G1AME5/8-G1/2
3/4	1/2	42.6	26.9	36.8	12.0	27	30	01034#09	G1AME3/4-G1/2
	3/4	42.6		36.8	16.0	27		01034#10	G1AME3/4-G3/4
1	3/4	50.3	32.5	41.7	16.0	35	38	01034#11	G1AME1-G3/4
	1	50.3		46.5	20.0	35		01034#12	G1AME1-G1

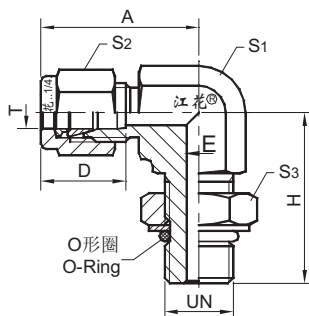
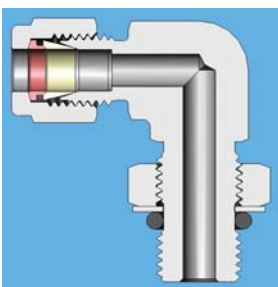

AME-UN

可调向外螺纹弯通终端接头-SAE/MS螺纹

Adjustable Male Elbow - SAE/MS Thread

Tube O.D. T	SAE Thread UN	A	D	H	E	S1	S2	Product No. 产品编号	Type 型号
1/4	7/16-20	26.6	15.5	18.8	4.8	12.7	14	01035#01	G1AME1/4-UN7/16-20
	9/16-18	30.5		23.4	4.8	15.9		01035#02	G1AME1/4-UN9/16-18
3/8	9/16-18	31.5	17.9	25.4	7.0	15.9	18	01035#03	G1AME3/8-UN9/16-18
	3/4-16	34.8		26.2	7.0	20.6		01035#04	G1AME3/8-UN3/4-16
1/2	3/4-16	36.2	22.8	28.2	10.5	20.6	22	01035#05	G1AME1/2-UN3/4-16
3/4	1 1/16-12	42.6	26.9	36.8	16.0	27	30	01035#06	G1AME3/4-UN1 1/16-12
1	1 5/16-12	50.3	32.5	41.7	22.0	35	38	01035#07	G1AME1-UN1 5/16-12

AMRT-G

可调向外螺纹直路三通终端接头-BSPB螺纹

Adjustable Male Run Tee - BSPB Thread

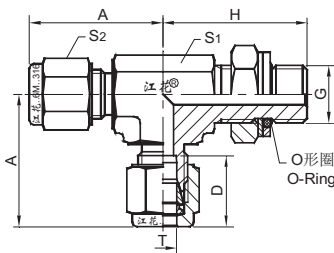
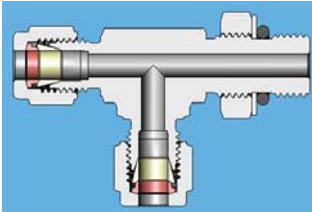

Tube O.D.	ISO BSPB	Product No.						Type	
T	G	A	D	H	E	S1	S2	产品编号	型号
米制管 For metric tube									
6	1/8	27.1	15.5	32.0	4.0	12.7	14	01036#01	G1AMRT6-G1/8
	1/4	29.0		32.5	4.8	14.3		01036#02	G1AMRT6-G1/4
8	1/8	29.5	16.7	32.0	4.0	14.3	17	01036#03	G1AMRT8-G1/8
	1/4	29.5		32.5	6.0	14.3		01036#04	G1AMRT8-G1/4
10	1/4	34.3	17.9	32.5	6.0	20.6	19	01036#05	G1AMRT10-G1/4
	3/8	34.3		37.0	8.0	20.6		01036#06	G1AMRT10-G3/8
12	1/4	36.2	22.8	35.0	6.0	20.6	22	01036#07	G1AMRT12-G1/4
	3/8	36.2		37.0	8.0	20.6		01036#08	G1AMRT12-G3/8
	1/2	38.2		43.0	9.5	27		01036#09	G1AMRT12-G1/2
	3/4	40.0		48.0	9.5	27		01036#10	G1AMRT12-G3/4
英制管 For fractional tube									
1/4	1/8	26.6	15.5	18.8	4.0	12.7	14	01037#01	G1AMRT1/4-G1/8
	1/4	27.3		23.4	4.8	14.3		01037#02	G1AMRT1/4-G1/4
3/8	1/4	31.5	17.9	25.4	6.0	15.9	18	01037#03	G1AMRT3/8-G1/4
	3/8	34.8		26.2	7.0	20.6		01037#04	G1AMRT3/8-G3/8
1/2	1/4	36.2	22.8	28.2	6.0	20.6	22	01037#05	G1AMRT1/2-G1/4
	3/8	36.2		28.2	8.0	20.6		01037#06	G1AMRT1/2-G3/8
	1/2	36.2		33.0	10.5	23.8		01037#07	G1AMRT1/2-G1/2
5/8	1/2	38.3	24.4	35.1	12.0	23.8	27	01037#08	G1AMRT5/8-G1/2
	3/4	1/2	42.6	26.9	36.8	12.0	27	30	01037#09
		3/4	42.6		36.8	16.0	27		01037#10
1	3/4	50.3	32.5	41.7	16.0	35	38	01037#11	G1AMRT1-G3/4
	1	50.3		46.5	20.0	35		01037#12	G1AMRT1-G1

AMRT-UN

可调向外螺纹直路三通终端接头-SAE/MS螺纹

Adjustable Male Run Tee- SAE/MS Thread

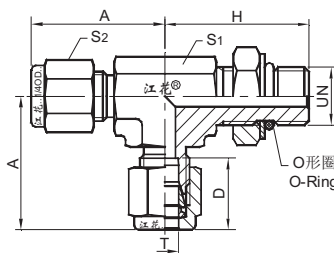
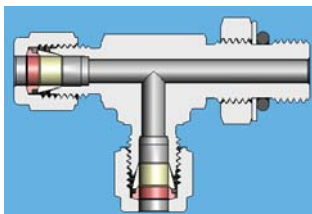

Tube O.D.	SAE Thread	Product No.						Type	
T	UN	A	D	H	E	S1	S2	产品编号	型号
1/4	7/16-20	26.6	15.5	18.8	4.8	12.7	14	01038#01	G1AMRT1/4-UN7/16-20
	9/16-18	30.5		23.4	4.8	15.9		01038#02	G1AMRT1/4-UN9/16-18
3/8	9/16-18	31.5	17.9	25.4	7.0	15.9	18	01038#03	G1AMRT3/8-UN9/16-18
	3/4-16	34.8		26.2	7.0	20.6		01038#04	G1AMRT3/8-UN3/4-16
1/2	3/4-16	36.2	22.8	28.2	10.5	20.6	22	01038#05	G1AMRT1/2-UN3/4-16
	1 1/16-12	42.6	26.9	36.8	16.0	27	30	01038#06	G1AMRT3/4-UN1 1/16-12
1	1 5/16-12	50.3	32.5	41.7	22.0	35	38	01038#07	G1AMRT1-UN1 5/16-12

AMBT-G

可调向外螺纹分支三通终端接头-BSPB螺纹

Adjustable Male Branch Tee - BSPP Thread

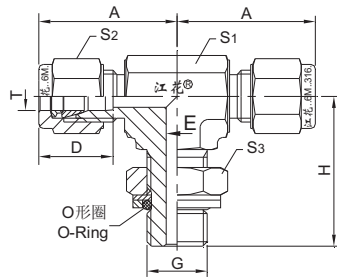
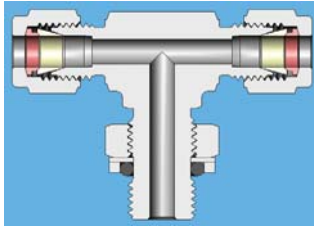

Tube O.D.	ISO BSPB							Product No.	Type
T	G	A	D	H	E	S1	S2	产品编号	型号
米制管 For metric tube									
6	1/8	27.1	15.5	32.0	4.0	12.7	14	01039#01	G1AMRTM6-G1/8
	1/4	29.0		32.5	4.8	14.3		01039#02	G1AMRTM6-G1/4
8	1/8	29.5	16.7	32.0	4.0	14.3	17	01039#03	G1AMRTM8-G1/8
	1/4	29.5		32.5	6.0	14.3		01039#04	G1AMRTM8-G1/4
10	1/4	34.3	17.9	32.5	6.0	20.6	19	01039#05	G1AMRTM10-G1/4
	3/8	34.3		37.0	8.0	20.6		01039#06	G1AMRTM10-G3/8
12	1/4	36.2	22.8	35.0	6.0	20.6	22	01039#07	G1AMRTM12-G1/4
	3/8	36.2		37.0	8.0	20.6		01039#08	G1AMRTM12-G3/8
	1/2	38.2		43.0	9.5	27		01039#09	G1AMRTM12-G1/2
	3/4	40.0		48.0	9.5	27		01039#10	G1AMRTM12-G3/4
英制管 For fractional tube									
1/4	1/8	26.6	15.5	18.8	4.0	12.7	14	01040#01	G1AMRT1/4-G1/8
	1/4	27.3		23.4	4.8	14.3		01040#02	G1AMRT1/4-G1/4
3/8	1/4	31.5	17.9	25.4	6.0	15.9	18	01040#03	G1AMRT3/8-G1/4
	3/8	34.8		26.2	7.0	20.6		01040#04	G1AMRT3/8-G3/8
1/2	1/4	36.2	22.8	28.2	6.0	20.6	22	01040#05	G1AMRT1/2-G1/4
	3/8	36.2		28.2	8.0	20.6		01040#06	G1AMRT1/2-G3/8
	1/2	36.2		33.0	10.5	23.8		01040#07	G1AMRT1/2-G1/2
5/8	1/2	38.3	24.4	35.1	12.0	23.8	27	01040#08	G1AMRT5/8-G1/2
	3/4	1/2	42.6	26.9	36.8	12.0	27	30	01040#09
		3/4	42.6		36.8	16.0	27		01040#10
1	3/4	50.3	32.5	41.7	16.0	35	38	01040#11	G1AMRT1-G3/4
	1	50.3		46.5	20.0	35		01040#12	G1AMRT1-G1

AMBT-UN

可调向外螺纹三通分支终端接头-SAE/MS螺纹

Adjustable Male Branch Tee- SAE/MS Thread

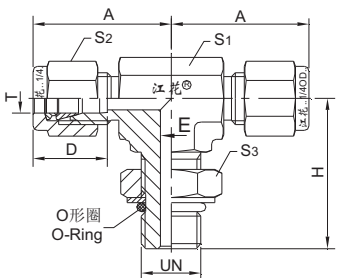
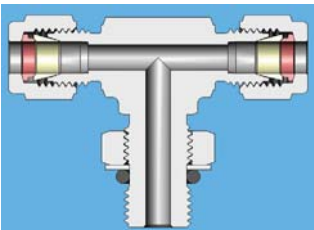

Tube O.D.	SAE Thread							Product No.	Type
T	UN	A	D	H	E	S1	S2	产品编号	型号
1/4	7/16-20	26.6	15.5	18.8	4.8	12.7	14	01041#01	G1AMRT1/4-UN7/16-20
	9/16-18	30.5		23.4	4.8	15.9		01041#02	G1AMRT1/4-UN9/16-18
3/8	9/16-18	31.5	17.9	25.4	7.0	15.9	18	01041#03	G1AMRT3/8-UN9/16-18
	3/4-16	34.8		26.2	7.0	20.6		01041#04	G1AMRT3/8-UN3/4-16
1/2	3/4-16	36.2	22.8	28.2	10.5	20.6	22	01041#05	G1AMRT1/2-UN3/4-16
	1 1/16-12	42.6	26.9	36.8	16.0	27	30	01041#06	G1AMRT3/4-UN1 1/16-12
1	1 5/16-12	50.3	32.5	41.7	22.0	35	38	01041#07	G1AMRT1-UN1 5/16-12

FCM-N

NPT内螺纹终端接头 (米制管)

NPT Female Connector (For metric tube)

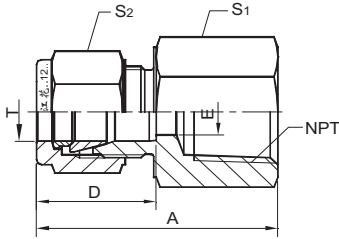
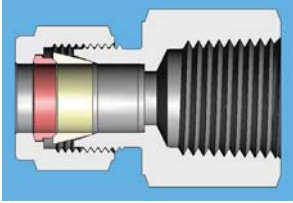

Tube O.D.	NPT	A	D	E	S1	S2	Product No. 产品编号	Type 型号
3	1/8	29.1	12.9	2.5	14	12	01042#01	G1FCM3-N1/8
	1/4	33.9		2.5	19		01042#02	G1FCM3-N1/4
4	1/8	30.5	14.5	2.5	14	12	01042#03	G1FCM4-N1/8
	1/4	36.0			19		01042#05	G1FCM6-N1/4
6	1/8	31.5	15.5	4.8	14	14	01042#04	G1FCM6-N1/8
	1/4	36.0			19		01042#05	G1FCM6-N1/4
	3/8	37.5			22		01042#06	G1FCM6-N3/8
	1/2	42.5			27		01042#07	G1FCM6-N1/2
8	1/8	32.7	16.7	6.5	15	17	01042#08	G1FCM8-N1/8
	1/4	37.7			19		01042#09	G1FCM8-N1/4
	3/8	39.2			22		01042#10	G1FCM8-N3/8
	1/2	44.2			27		01042#11	G1FCM8-N1/2
10	1/4	38.4	17.9	8.0	19	19	01042#12	G1FCM10-N1/4
	3/8	40.4			22		01042#13	G1FCM10-N3/8
	1/2	44.9			27		01042#14	G1FCM10-N1/2
12	1/4	42.3	22.8	9.5	22	22	01042#15	G1FCM12-N1/4
	3/8	42.3			22		01042#16	G1FCM12-N3/8
	1/2	46.8			27		01042#17	G1FCM12-N1/2
14	1/2	46.8	24.4	11.0	27	27	01042#18	G1FCM14-N1/2
15	1/2	46.8	24.4	12.0	27		01042#19	G1FCM15-N1/2
16	3/8	42.3	24.4	13.0	27	27	01042#20	G1FCM15-N3/8
	1/2	46.8			27		01042#21	G1FCM16-N1/2
20	1/2	50.9	28.9	16.0	30	32	01042#22	G1FCM20-N1/2
	3/4	52.4			36		01042#23	G1FCM20-N3/4
22	3/4	52.6	29.1	18.5	36	32	01042#24	G1FCM22-N3/4
	1	61.1			41		01042#25	G1FCM22-N1
25	3/4	54.9	32.4	22.0	36	38	01042#26	G1FCM25-N3/4
	1	63.4			41		01042#27	G1FCM25-N1

FC-N

NPT内螺纹终端接头 (英制管)

NPT Female Connector (For fractional tube)

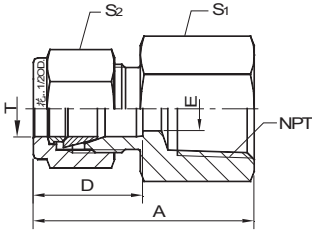
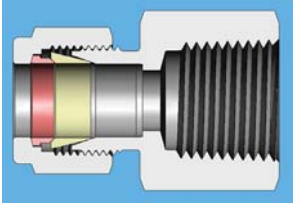

Tube O.D.	NPT	A	D	E	S1	S2	Product No. 产品编号	Type 型号
1/8	1/8	29.3	12.9	2.5	14	12	01043#01	G1FC1/8-N1/8
	1/4	33.8		2.5	19		01043#02	G1FC1/8-N1/4
3/16	1/8	30.7	14.6	3.0	14	12	01043#03	G1FC3/16-N1/8
	1/4	35.3		3.0	19		01043#04	G1FC3/16-N1/4
1/4	1/8	31.4	15.5	5.0	14	14	01043#05	G1FC1/4-N1/8
	1/4	36.2		5.0	19		01043#06	G1FC1/4-N1/4
	3/8	37.7		5.0	22		01043#07	G1FC1/4-N3/8
	1/2	42.6		5.0	27		01043#08	G1FC1/4-N1/2
5/16	1/8	32.8	16.7	6.5	14	17	01043#09	G1FC5/16-N1/8
	1/4	37.7		6.5	19		01043#10	G1FC5/16-N1/4
	3/8	39.2		6.5	22		01043#11	G1FC5/16-N3/8
3/8	1/8	33.8	17.9	7.0	17	18	01043#12	G1FC3/8-N1/8
	1/4	38.6			19		01043#13	G1FC3/8-N1/4
	3/8	40.2			22		01043#14	G1FC3/8-N3/8
	1/2	45.0			27		01043#15	G1FC3/8-N1/2
	3/4	48.0			32		01043#16	G1FC3/8-N3/4
1/2	1/4	40.5	22.8	10.5	22	22	01043#17	G1FC1/2-N1/4
	3/8	42.1			22		01043#18	G1FC1/2-N3/8
	1/2	46.9			27		01043#19	G1FC1/2-N1/2
	3/4	49.9			32		01043#20	G1FC1/2-N3/4
5/8	3/8	42.1	24.4	13.0	24	27	01043#21	G1FC5/8-N3/8
	1/2	46.9			27		01043#22	G1FC5/8-N1/2
	3/4	49.9			32		01043#23	G1FC5/8-N3/4
3/4	1/2	49.5	26.9	16.0	27	30	01043#24	G1FC3/4-N1/2
	3/4	52.5			32		01043#25	G1FC3/4-N3/4
7/8	3/4	52.7	29.1	18.5	32	32	01043#26	G1FC7/8-N3/4
1	3/4	55.7	32.5	22.0	36	28	01043#27	G1FC1-N3/4
	1	63.54			41		01043#28	G1FC1-N1

FCM-Rc

BSPT(Rc)内螺纹终端接头 (米制管)

BSP Taper Female Connector (For metric tube)

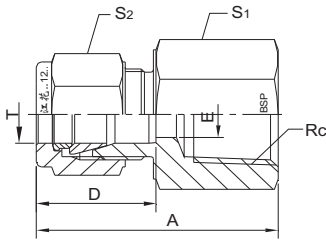
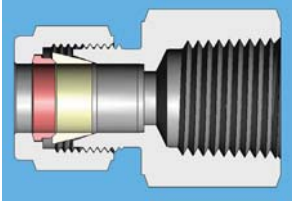

Tube O.D. T	BSPT Thread Rc	A	D	E	S1	S2	Product No. 产品编号	Type 型号
3	1/8	29.1	12.9	2.5	14	12	01044#01	G1FCM3-Rc1/8
6	1/8	31.5	15.3	4.8	14	14	01044#02	G1FCM6-Rc1/8
	1/4	36.0	15.3		19		01044#03	G1FCM6-Rc1/4
	3/8	37.5	15.3		22		01044#04	G1FCM6-Rc3/8
8	1/2	42.5	15.3	6.5	27		01044#05	G1FCM6-Rc1/2
	1/8	32.7	16.2		15	17	01044#06	G1FCM8-Rc1/8
	1/4	37.7	16.2		19		01044#07	G1FCM8-Rc1/4
10	3/8	39.2	16.2	8.0	22		01044#08	G1FCM8-Rc3/8
	1/2	44.2	16.2		27		01044#09	G1FCM8-Rc1/2
	1/4	38.4	17.2		19	19	01044#10	G1FCM10-Rc1/4
12	3/8	40.4	17.2	9.5	22		01044#11	G1FCM10-Rc3/8
	1/2	44.9	17.2		27		01044#12	G1FCM10-Rc1/2
	1/4	42.3	22.8		22	22	01044#13	G1FCM12-Rc1/4
14	3/8	42.3	22.8	11.0	22		01044#14	G1FCM12-Rc3/8
	1/2	46.8	22.8		27		01044#15	G1FCM12-Rc1/2
	1/2	46.8	24.4		27	27	01044#16	G1FCM14-Rc1/2
15	1/2	46.8	24.4	12.0	27		01044#17	G1FCM15-Rc1/2
	3/8	42.3	24.4		27	27	01044#18	G1FCM16-Rc3/8
16	1/2	46.8	24.4	13.0	27		01044#19	G1FCM16-Rc1/2
	1/2	50.9	26.0		30	32	01044#20	G1FCM20-Rc1/2
20	3/4	52.4	26.0	16.0	36		01044#21	G1FCM20-Rc3/4
	3/4	52.6	26.0		36	32	01044#22	G1FCM22-Rc3/4
22	1	61.1	26.0	18.5	41		01044#23	G1FCM22-Rc1
	3/4	54.9	31.3		36	38	01044#24	G1FCM25-Rc3/4
25	1	63.4	31.3	22.0	41		01044#25	G1FCM25-Rc1

FC-Rc

BSPT(Rc)内螺纹终端接头 (英制管)

BSP Taper Female Connector (For fractional tube)

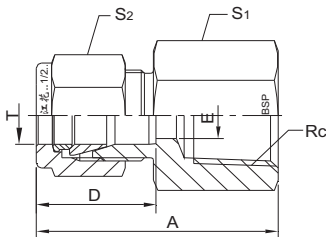
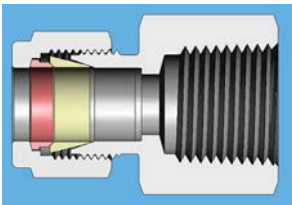

Tube O.D. T	BSPT Thread Rc	A	D	E	S1	S2	Product No. 产品编号	Type 型号
1/4	1/8	31.4	15.5	5.0	14	14	01045#01	G1FC1/4-Rc1/8
	1/4	36.2			19		01045#02	G1FC1/4-Rc1/4
	3/8	37.7			22		01045#03	G1FC1/4-Rc3/8
	1/2	42.6			27		01045#04	G1FC1/4-Rc1/2
3/8	1/4	38.6	17.9	7.0	19	18	01045#05	G1FC3/8-Rc1/4
	3/8	40.2			22		01045#06	G1FC3/8-Rc3/8
	1/2	45.0			27		01045#07	G1FC3/8-Rc1/2
1/2	1/4	40.5	22.8	10.5	22	22	01045#08	G1FC1/2-Rc1/4
	3/8	42.1			22		01045#09	G1FC1/2-Rc3/8
	1/2	46.9			27		01045#10	G1FC1/2-Rc1/2

GA-G
压力表接头-BSPP(G)螺纹
Gauge Adapters - BSPP(G) Thread

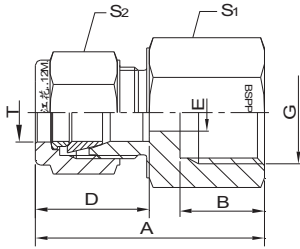
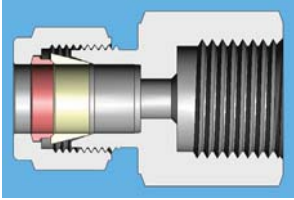

Tube O.D.	BSPP Thread							Product No.	Type
T	G	A	B	D	E	S1	S2	产品编号	型号
米制管 For metric tube									
3	1/4	35.9	13.0	12.9	2.5	14	12	01046#01	G1GAM3-G1/8
6	1/4	37.5	13.0	15.5	4.8	19	14	01046#02	G1GAM6-G1/4
	3/8	37.5	14.0					01046#03	G1GAM6-G3/8
	1/2	43.5	19.0					01046#04	G1GAM6-G1/2
8	1/4	39.2	13.0	16.7	5.5	19	17	01046#05	G1GAM8-G1/4
	3/8	41.7	14.0					01046#06	G1GAM8-G3/8
	1/2	44.7	19.0					01046#07	G1GAM8-G1/2
10	1/4	40.4	13.0	17.9	5.5	19	19	01046#08	G1GAM10-G1/4
	3/8	40.4	14.0					01046#09	G1GAM10-G3/8
	1/2	42.4	19.0					01046#10	G1GAM10-G1/2
12	1/4	42.3	13.0	22.8	5.5	22	22	01046#11	G1GAM12-G1/4
	3/8	44.8	14.0					01046#12	G1GAM12-G3/8
	1/2	48.3	19.0					01046#13	G1GAM12-G1/2
英制管 For fractional tube									
1/4	1/4	37.5	13.0	15.5	4.8	19	14	01047#01	G1GA1/4-G1/4
	3/8	37.5	14.0					01047#02	G1GA1/4-G3/8
	1/2	43.5	19.0					01047#03	G1GA1/4-G1/2
5/16	1/4	39.2	13.0	16.7	5.5	19	17	01047#04	G1GA5/16-G1/4
	1/2	41.2	19.0					01047#05	G1GA5/16-G1/2
3/8	1/4	40.4	13.0	17.9	5.5	19	18	01047#06	G1GA3/8-G1/4
	3/8	40.4	14.0					01047#07	G1GA3/8-G3/8
	1/2	42.4	19.0					01047#08	G1GA3/8-G1/2
1/2	3/8	44.8	14.0	22.8	6.5	22	22	01047#09	G1GA1/2-G3/8
	1/2	48.3	19.0					01047#10	G1GA1/2-G1/2

GAM-M
压力表接头-米制螺纹M (米制管)
Gauge Adapters - M Thread (For metric tube)

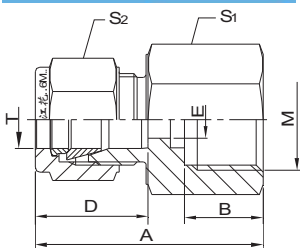
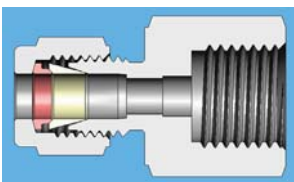

Tube O.D.	M							Product No.	Type
T	M	A	B	D	E	S1	S2	产品编号	型号
6	M10×1	37.5	10.0	15.5	4.8	17	14	01048#01	G1GAM6-M10×1
	M14×1.5	37.5	13.0					01048#02	G1GAM6-M14×1.5
	M20×1.5	43.5	19.0					01048#03	G1GAM6-M20×1.5
12	M14×1.5	42.3	13.0	22.8	5.5	22	22	01048#04	G1GAM12-M14×1.5
	M20×1.5	48.3	19.0					01048#05	G1GAM12-M20×1.5
14	M20×1.5	48.3	19.0	24.4	7.0	27	27	01048#06	G1GAM15-M20×1.5

FEM-N

NPT内螺纹弯通终端接头 (米制管)

NPT Female Elbow (For metric tube)

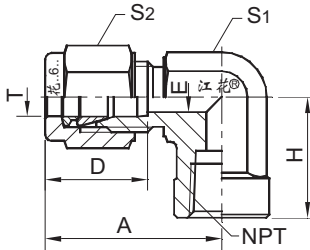
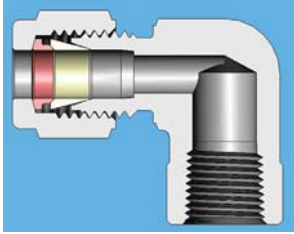

Tube O.D. T	NPT	A	D	H	E	S1	S2	Product No.	Type
								产品编号	型号
6	1/8	27.1	15.5	19.0	4.8	12.7	14	01049#01	G1FEM6-N1/8
	1/4	29.9		22.5		17.5		01049#02	G1FEM6-N1/4
8	1/8	29.5	16.7	19.0	6.5	14.3	17	01049#03	G1FEM8-N1/8
	1/4	31.3		22.5		17.5		01049#04	G1FEM8-N1/4
10	1/8	32.3	17.9	22.5	8.0	17.5	19	01049#05	G1FEM10-N1/8
	1/4	34.3		22.5		20.6		01049#06	G1FEM10-N1/4
	3/8	34.3		22.5		20.6		01049#07	G1FEM10-N3/8
	1/2	39.0		28.5		25.4		01049#08	G1FEM10-N1/2
12	1/4	36.2	22.8	22.5	9.5	20.6	22	01049#09	G1FEM12-N1/4
	3/8	36.2		22.5		20.6		01049#10	G1FEM12-N3/8
	1/2	38.2		28.5		25.4		01049#11	G1FEM12-N1/2
16	3/8	40.0	24.4	23.5	13.0	27	27	01049#12	G1FEM16-N3/8
	1/2	40.0		28.5		27		01049#13	G1FEM16-N1/2
18	1/2	42.6	26.9	28.5	16.0	27	30	01049#14	G1FEM18-N1/2
20	1/2	47.4	28.9	28.5	16.0	35	32	01049#15	G1FEM20-N1/2
22	3/4	47.6	29.1	32.0	18.5	35	32	01049#16	G1FEM22-N3/4
25	3/4	50.2	32.4	32.0	22.5	35	38	01049#17	G1FEM25-N3/4

FE-N

NPT内螺纹弯通终端接头 (英制管)

NPT Female Elbow (For fractional tube)

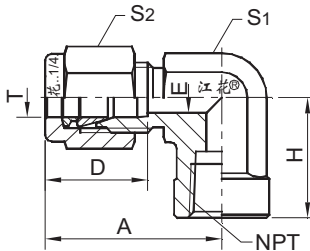
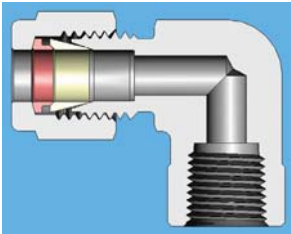

Tube O.D. T	NPT	A	D	H	E	S1	S2	Product No.	Type
								产品编号	型号
1/8	1/8	25.2	12.9	19.0	2.5	12.7	12	01050#01	G1FE1/8-N1/8
	1/4	28.2		22.5		17.5		01050#02	G1FE1/8-N1/4
3/16	1/8	26.7	14.6	19.0	3.0	12.7	12	01050#03	G1FE3/16-N1/8
	1/4	1/8	27.3	15.5	19.0	5.0	12.7	14	01050#04
		1/4	30.6		22.5		17.5		01050#05
	3/8	32.1		22.5		20.6		01050#06	G1FE1/4-N3/8
5/16	1/8	30.6	16.7	19.0	6.5	14.3	17	01050#07	G1FE5/16-N1/8
	1/4	32.1		22.5		17.5		01050#08	G1FE5/16-N1/4
3/8	1/8	31.5	17.9	19.0	7.0	15.9	18	01050#09	G1FE3/8-N1/8
	1/4	33.0		22.5		17.5		01050#10	G1FE3/8-N1/4
	3/8	34.6		22.5		20.6		01050#11	G1FE3/8-N3/8
1/2	1/4	36.2	22.8	22.5	10.5	20.6	22	01050#12	G1FE1/2-N1/4
	3/8	36.5		22.5		20.6		01050#13	G1FE1/2-N3/8
	1/2	39.0		28.5		25.4		01050#14	G1FE1/2-N1/2
5/8	3/8	36.5	24.4	22.5	13.0	23.8	27	01050#15	G1FE5/8-N3/8
	1/2	39.0		28.5		27		01050#16	G1FE5/8-N1/2
3/4	1/2	42.4	26.9	28.5	16.0	27	30	01050#17	G1FE3/4-N1/2
	3/4	47.4		32.0		35		01050#18	G1FE3/4-N3/4
7/8	3/4	47.6	29.1	32.0	18.5	35	32	01050#19	G1FE7/8-N3/4
1	3/4	50.3	32.5	32.0	22.5	35	38	01050#20	G1FE1-N3/4

FRTM-N

NPT内螺纹直路三通终端接头 (米制管)

NPT Female Run Tee (For metric tube)

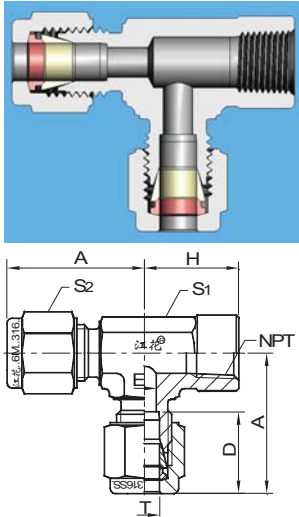

Tube O.D.								Product No.	Type
T	NPT	A	D	H	E	S1	S2	产品编号	型号
6	1/8	27.1	15.5	19.0	4.8	12.7	14	01051#01	G1FRTM6-N1/8
	1/4	29.9		22.5		17.5		01051#02	G1FRTM6-N1/4
8	1/8	29.5	16.7	19.0	6.5	14.3	17	01051#03	G1FRTM8-N1/8
	1/4	31.3		22.5		17.5		01051#04	G1FRTM8-N1/4
10	1/8	32.3	17.9	22.5	8.0	17.5	19	01051#05	G1FRTM10-N1/8
	1/4	34.3		22.5		20.6		01051#06	G1FRTM10-N1/4
	3/8	34.3		22.5		20.6		01051#07	G1FRTM10-N3/8
	1/2	39.0		28.5		25.4		01051#08	G1FRTM10-N1/2
12	1/4	36.2	22.8	22.5	9.5	20.6	22	01051#09	G1FRTM12-N1/4
	3/8	36.2		22.5		20.6		01051#10	G1FRTM12-N3/8
	1/2	38.2		28.5		25.4		01051#11	G1FRTM12-N1/2
16	3/8	40.0	24.4	23.5	13.0	27	27	01051#12	G1FRTM16-N3/8
	1/2	40.0		28.5		27		01051#13	G1FRTM16-N1/2
18	1/2	42.6	26.9	28.5	16.0	27	30	01051#14	G1FRTM18-N1/2
20	1/2	47.4	28.9	28.5	16.0	35	32	01051#15	G1FRTM20-N1/2
22	3/4	47.6	29.1	32.0	18.5	35	32	01051#16	G1FRTM22-N3/4
25	3/4	50.2	32.4	32.0	22.5	35	38	01051#17	G1FRTM25-N3/4

FRT-N

NPT内螺纹直路三通终端接头 (英制管)

NPT Female Run Tee (For fractional tube)

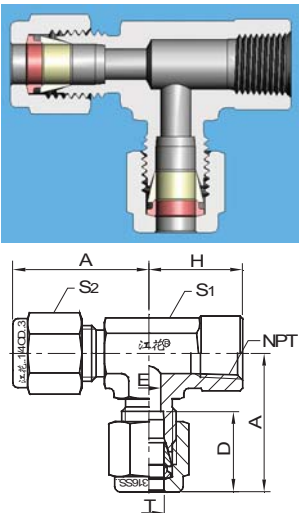

Tube O.D.								Product No.	Type
T	NPT	A	D	H	E	S1	S2	产品编号	型号
1/8	1/8	25.2	12.9	19.0	2.5	12.7	12	01052#01	G1FRT1/8-N1/8
	1/4	28.2		22.5		17.5		01052#02	G1FRT1/8-N1/4
3/16	1/8	26.7	14.6	19.0	3.0	12.7	12	01052#03	G1FRT3/16-N1/8
1/4	1/8	27.3	15.5	19.0	5.0	12.7	14	01052#04	G1FRT1/4-N1/8
	1/4	30.6		22.5		17.5		01052#05	G1FRT1/4-N1/4
	3/8	32.1		22.5		20.6		01052#06	G1FRT1/4-N3/8
5/16	1/8	30.6	16.7	19.0	6.5	14.3	17	01052#07	G1FRT5/16-N1/8
	1/4	32.1		22.5		17.5		01052#08	G1FRT5/16-N1/4
3/8	1/8	31.5	17.9	19.0	7.0	15.9	18	01052#09	G1FRT3/8-N1/8
	1/4	33.0		22.5		17.5		01052#10	G1FRT3/8-N1/4
	3/8	34.6		22.5		20.6		01052#11	G1FRT3/8-N3/8
1/2	1/4	36.2	22.8	22.5	10.5	20.6	22	01052#12	G1FRT1/2-N1/4
	3/8	36.5		22.5		20.6		01052#13	G1FRT1/2-N3/8
	1/2	39.0		28.5		25.4		01052#14	G1FRT1/2-N1/2
5/8	3/8	36.5	24.4	22.5	13.0	23.8	27	01052#15	G1FRT5/8-N3/8
	1/2	39.0		28.5		27		01052#16	G1FRT5/8-N1/2
3/4	1/2	42.4	26.9	28.5	16.0	27	30	01052#17	G1FRT3/4-N1/2
	3/4	47.4		32.0		35		01052#18	G1FRT3/4-N3/4
7/8	3/4	47.6	29.1	32.0	18.5	35	32	01052#19	G1FRT7/8-N3/4
1	3/4	50.3	32.5	32.0	22.5	35	38	01052#20	G1FRT1-N3/4

FBTM-N

NPT内螺纹分支三通终端接头 (米制管)

NPT Female Branch Tee (For metric tube)

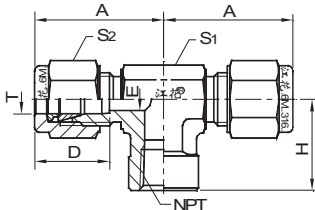
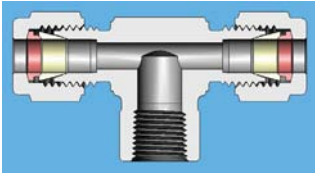

Tube O.D.								Product No.	Type
T	NPT	A	D	H	E	S1	S2	产品编号	型号
6	1/8	27.1	15.5	19.0	4.8	12.7	14	01053#01	G1FBTM6-N1/8
	1/4	29.9		22.5		17.5		01053#02	G1FBTM6-N1/4
8	1/8	29.5	16.7	19.0	6.5	14.3	17	01053#03	G1FBTM8-N1/8
	1/4	31.3		22.5		17.5		01053#04	G1FBTM8-N1/4
10	1/8	32.3	17.9	22.5	8.0	17.5	19	01053#05	G1FBTM10-N1/8
	1/4	34.3		22.5		20.6		01053#06	G1FBTM10-N1/4
	3/8	34.3		22.5		20.6		01053#07	G1FBTM10-N3/8
	1/2	39.0		28.5		25.4		01053#08	G1FBTM10-N1/2
12	1/4	36.2	22.8	22.5	9.5	20.6	22	01053#09	G1FBTM12-N1/4
	3/8	36.2		22.5		20.6		01053#10	G1FBTM12-N3/8
	1/2	38.2		28.5		25.4		01053#11	G1FBTM12-N1/2
16	3/8	40.0	24.4	23.5	13.0	27	27	01053#12	G1FBTM16-N3/8
	1/2	40.0		28.5		27		01053#13	G1FBTM16-N1/2
18	1/2	42.6	26.9	28.5	16.0	27	30	01053#14	G1FBTM18-N1/2
20	1/2	47.4	28.9	28.5	16.0	35	32	01053#15	G1FBTM20-N1/2
22	3/4	47.6	29.1	32.0	18.5	35	32	01053#16	G1FBTM22-N3/4
25	3/4	50.2	32.4	32.0	22.5	35	38	01053#17	G1FBTM25-N3/4

FBT-N

NPT内螺纹分支三通终端接头 (英制管)

NPT Female Branch Tee (For fractional tube)

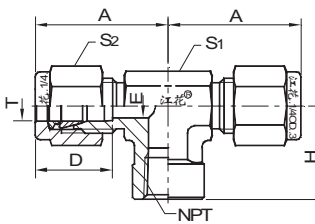
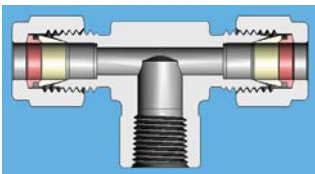

Tube O.D.								Product No.	Type
T	NPT	A	D	H	E	S1	S2	产品编号	型号
1/8	1/8	25.2	12.9	19.0	2.5	12.7	12	01054#01	G1FBT1/8-N1/8
	1/4	28.2		22.5		17.5		01054#02	G1FBT1/8-N1/4
3/16	1/8	26.7	14.6	19.0	3.0	12.7	12	01054#03	G1FBT3/16-N1/8
1/4	1/8	27.3	15.5	19.0	5.0	12.7	14	01054#04	G1FBT1/4-N1/8
	1/4	30.6		22.5		17.5		01054#05	G1FBT1/4-N1/4
	3/8	32.1		22.5		20.6		01054#06	G1FBT1/4-N3/8
5/16	1/8	30.6	16.7	19.0	6.5	14.3	17	01054#07	G1FBT5/16-N1/8
	1/4	32.1		22.5		17.5		01054#08	G1FBT5/16-N1/4
3/8	1/8	31.5	17.9	19.0	7.0	15.9	18	01054#09	G1FBT3/8-N1/8
	1/4	33.0		22.5		17.5		01054#10	G1FBT3/8-N1/4
	3/8	34.6		22.5		20.6		01054#11	G1FBT3/8-N3/8
1/2	1/4	36.2	22.8	22.5	10.5	20.6	22	01054#12	G1FBT1/2-N1/4
	3/8	36.5		22.5		20.6		01054#13	G1FBT1/2-N3/8
	1/2	39.0		28.5		25.4		01054#14	G1FBT1/2-N1/2
5/8	3/8	36.5	24.4	22.5	13.0	23.8	27	01054#15	G1FBT5/8-N3/8
	1/2	39.0		28.5		27		01054#16	G1FBT5/8-N1/2
3/4	1/2	42.4	26.9	28.5	16.0	27	30	01054#17	G1FBT3/4-N1/2
	3/4	47.4		32.0		35		01054#18	G1FBT3/4-N3/4
7/8	3/4	47.6	29.1	32.0	18.5	35	32	01054#19	G1FBT7/8-N3/4
1	3/4	50.3	32.5	32.0	22.5	35	38	01054#20	G1FBT1-N3/4

BWCM

焊接直通接头 (米制管)

Buttweld Connector (For metric tube)

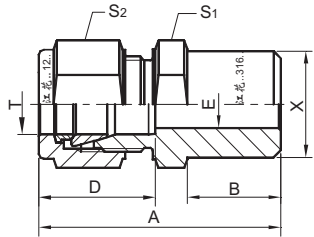
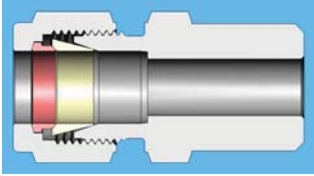

Tube O.D. T	Butt-weld Pipe NB.	A	B	D	X	S1	S2	Product No. 产品编号	Type 型号
3	1/8	30.0	9.5	12.9	10.3	12	12	01055#01	G1BWCM3-1/8
4	1/8	31.6	9.5	14.5	10.3	12	12	01055#02	G1BWCM4-1/8
6	1/8	32.9	9.5	15.5	10.3	14	14	01055#03	G1BWCM6-1/8
6	1/4	37.7	14.2		13.7	14	14	01055#04	G1BWCM6-1/4
8	1/8	34.9	9.5	16.7	10.3	15	17	01055#05	G1BWCM8-1/8
	1/4	39.4	14.2		13.7	15		01055#06	G1BWCM8-1/4
	1/2	45.5	19.0		21.3	22		01055#07	G1BWCM8-1/2
10	1/4	40.9	14.2	17.9	13.7	18	19	01055#08	G1BWCM10-1/4
	3/8	41.7	14.2		17.1	18		01055#09	G1BWCM10-3/8
	1/2	46.5	19.0		21.3	22		01055#10	G1BWCM10-1/2
12	1/4	43.6	14.2	22.8	13.7	22	22	01055#11	G1BWCM12-1/4
	3/8	43.6	14.2		17.1			01055#12	G1BWCM12-3/8
	1/2	48.4	19.0		21.3			01055#13	G1BWCM12-1/2
14	3/8	49.2	14.2	24.4	17.1	24	27	01055#14	G1BWCM14-3/8
15	1/2	49.2	19.0		21.3	24	27	01055#15	G1BWCM15-1/2
16	1/2	49.2	19.0		21.3	24	27	01055#16	G1BWCM16-1/2
18	1/2	53.3	19.0		21.3	27	30	01055#17	G1BWCM18-1/2

BWC

焊接直通接头 (英制管)

Buttweld Connector (For fractional tube)

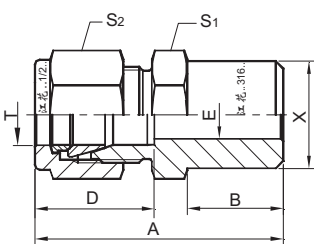
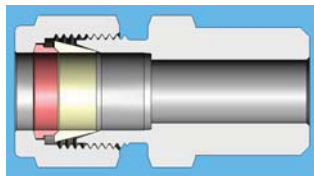

Tube O.D. T	Butt-weld Pipe NB.	A	B	D	X	S1	S2	Product No. 产品编号	Type 型号
1/8	1/8	30.8	9.5	12.9	10.3	12	12	01056#01	G1BWC1/8-1/8
3/16	1/8	32.2	9.5	14.6	10.3	12	12	01056#02	G1BWC3/16-1/8
1/4	1/8	32.9	9.5	15.5	10.3	14	14	01056#03	G1BWC1/4-1/8
	1/4	38.0	14.3		13.7	14		01056#04	G1BWC1/4-1/4
5/16	1/8	39.2	9.5	16.7	10.3	15	17	01056#05	G1BWC5/16-1/8
	1/4	39.4	14.3		13.7	15		01056#06	G1BWC5/16-1/4
3/8	1/4	40.9	14.3	17.9	13.7	17	18	01056#07	G1BWC3/8-1/4
	3/8	41.7	14.3		17.1	18		01056#08	G1BWC3/8-3/8
	1/2	47.3	19.0		21.3	22		01056#09	G1BWC3/8-1/2
	3/4	48.8	19.0		26.7	27		01056#10	G1BWC3/8-3/4
1/2	3/8	43.6	14.3	22.8	17.1	22	22	01056#11	G1BWC1/2-3/8
	1/2	49.2	19.0		21.3	22		01056#12	G1BWC1/2-1/2
	3/4	50.7	19.0		26.7	27		01056#13	G1BWC1/2-3/4
5/8	1/2	49.2	19.0	24.4	21.3	24	27	01056#14	G1BWC5/8-1/2
3/4	3/4	53.3	19.0	26.9	26.7	27	30	01056#15	G1BWC3/4-3/4
1	1	63.5	24	32.5	33.4	36	38	01056#16	G1BWC1-1

注: 对焊端一般按SCH80, 除非另外标注.

NOTE: Pipe buttweld end will conform to Schedule 80 unless otherwise noted.

BWEM

焊接弯通接头 (米制管)

Bettweld Elbow (For metric tube)

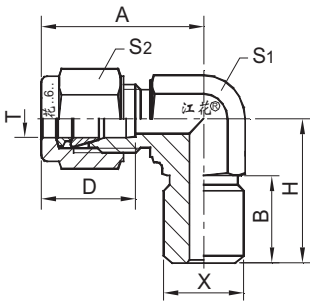
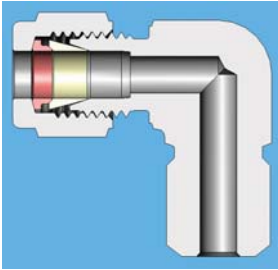

Tube O.D. T	Butt-weld Pipe NB.	A	D	H	B	X	S1	S2	Product No. 产品编号	Type 型号
3	1/8	23.9	12.9	17.8	9.7	10.3	11.1	12	01057#01	G1BWEM3-1/8
4	1/8	26.3	14.5	18.8	9.7	10.3	12.7	12	01057#02	G1BWEM4-1/8
6	1/8	27.1	15.5	18.8	9.7	10.3	12.7	14	01057#03	G1BWEM6-1/8
	1/4	27.1		23.4	14.2	13.7	12.7		01057#04	G1BWEM6-1/4
8	1/8	29.5	16.7	19.8	9.7	10.3	14.3	17	01057#05	G1BWEM8-1/8
	1/4	29.5		24.4	14.2	13.7	14.3		01057#06	G1BWEM8-1/4
	1/2	33.4		33.0	19.0	21.3	20.6		01057#07	G1BWEM8-1/2
10	1/4	32.3	17.2	26.2	14.2	13.7	17.5	19	01057#08	G1BWEM10-1/4
	3/8	32.3		26.2	14.2	17.1	17.5		01057#09	G1BWEM10-3/8
	1/2	34.3		33.0	19.0	21.3	20.6		01057#10	G1BWEM10-1/2
12	1/4	36.2	22.8	28.2	14.2	13.7	20.6	22	01057#11	G1BWEM12-1/4
	3/8	36.2		28.2	14.2	17.1			01057#12	G1BWEM12-3/8
	1/2	36.2		33.0	19.0	21.3			01057#13	G1BWEM12-1/2
14	1/2	38.2	24.4	35.1	19.0	21.3	23.8	27	01057#14	G1BWEM14-1/2
15	1/2	38.2	24.4	35.1	19.0	21.3	23.8	27	01057#15	G1BWEM15-1/2
16	1/2	38.2	24.4	35.1	19.0	21.3	23.8	27	01057#16	G1BWEM16-1/2
18	1/2	42.6	26.9	36.8	19.0	21.3	27	30	01057#17	G1BWEM18-1/2

BWE

焊接弯通接头 (英制管)

Buttweld Elbow (For fractional tube)

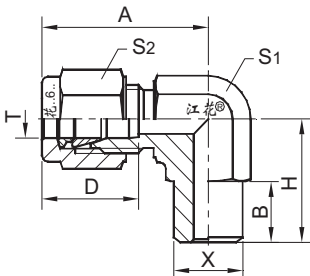
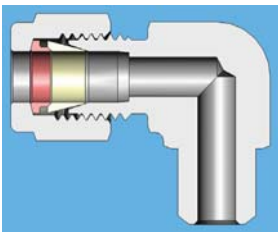

Tube O.D. T	Butt-weld Pipe NB.	A	D	H	B	X	S1	S2	Product No. 产品编号	Type 型号
1/8	1/8	24.0	12.9	17.8	9.7	10.3	11.1	12	01058#01	G1BWE1/8-1/8
3/16	1/8	26.4	14.6	18.8	9.7	10.3	12.7	12	01058#02	G1BWE3/16-1/8
1/4	1/8	27.2	15.5	18.8	9.7	10.3	12.7	14	01058#03	G1BWE1/4-1/8
	1/4	27.2		23.4	14.3	13.7	12.7		01058#04	G1BWE1/4-1/4
3/8	1/4	31.5	17.9	25.4	14.3	13.7	15.9	18	01058#05	G1BWE3/8-1/4
1/2	3/8	36.2	22.8	28.2	14.3	17.1	20.6	22	01058#06	G1BWE1/2-3/8
	1/2	36.2		33.0	19.0	21.3	20.6		01058#07	G1BWE1/2-1/2
5/8	1/2	38.3	24.4	35.1	19.0	21.3	23.8	27	01058#08	G1BWE5/8-1/2
3/4	3/4	42.6	26.9	36.8	19.0	26.7	27	30	01058#09	G1BWE3/4-3/4
1	3/4	50.3	32.5	41.7	19.0	26.7	35	38	01058#10	G1BWE1-3/4
	1	50.3		46.5	24.0	33.4	35		01058#11	G1BWE1-1

SWCM

承插焊接直通接头 (米制管)

Tube Socket weld Union (For metric tube)

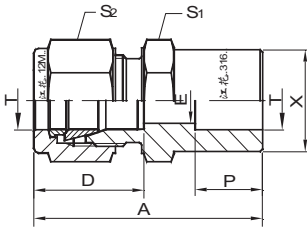
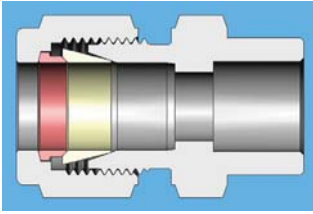

Tube O.D.	Product No.						Type
T	A	D	P	X	S1	S2	产品编号 型号
3	29.4	12.9	6.5	8.0	12	12	01059#01 G1SWCM3
4	30.5	14.5	6.5	10.0	12	12	01059#02 G1SWCM4
6	33.5	15.5	8.0	12.0	14	14	01059#03 G1SWCM6
8	37.2	16.7	9.0	14.0	15	17	01059#04 G1SWCM8
10	38.4	17.9	10.0	16.0	18	19	01059#05 G1SWCM10
12	41.3	22.8	12.5	19.0	22	22	01059#06 G1SWCM12
14	42.3	24.4	12.5	22.5	24	27	01059#07 G1SWCM14
16	42.3	24.4	13.0	23.8	24	27	01059#08 G1SWCM16
20	46.9	28.9	14.0	26.8	27	30	01059#09 G1SWCM20
22	51.1	29.1	14.0	29.8	30	32	01059#10 G1SWCM22
25	53.9	32.4	14.0	33.5	35	38	01059#11 G1SWCM25

SWC

焊接直通接头 (英制管)

Tube Socket weld Union (For fractional tube)

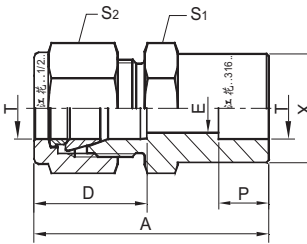
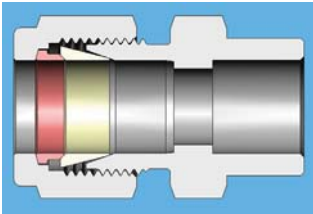

Tube O.D.	Product No.						Type
T	A	D	P	X	S1	S2	产品编号 型号
1/8	29.4	12.9	4.0	10.0	12	12	01060#01 G1SWC1/8
3/16	30.6	14.6	5.0	11.0	12	12	01060#02 G1SWC3/16
1/4	33.5	15.5	6.5	12.0	14	14	01060#03 G1SWC1/4
3/8	38.2	17.9	8.5	16.0	17	18	01060#04 G1SWC3/8
1/2	41.3	22.8	10.5	20.0	22	22	01060#05 G1SWC1/2
5/8	42.3	24.4	12.5	23.5	24	27	01060#06 G1SWC5/8
3/4	46.4	26.9	13.0	26.8	27	30	01060#07 G1SWC3/4
1	54.0	32.5	14.0	34.5	36	38	01060#08 G1SWC1

SWEM

承插焊弯通接头 (米制管)

Tube Socket Weld Elbow (For metric tube)

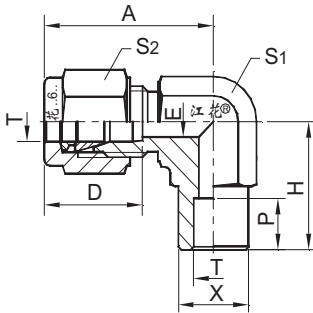
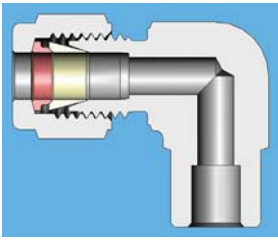

Tube O.D.	A	D	E	H	P	X	S1	S2	Product No.	Type
T									产品编号	型号
3	23.9	12.9	2.5	16.0	6.5	8.0	11.1	12	01061#01	G1SWEM3
4	26.3	14.5	2.5	17.5	6.5	10.0	12.7	12	01061#02	G1SWEM4
6	27.1	15.5	4.8	19.6	8.0	12.0	12.7	14	01061#03	G1SWEM6
8	29.5	16.7	6.5	21.0	9.0	14.0	14.3	17	01061#04	G1SWEM8
10	32.3	17.9	8.0	23.0	10.0	16.0	17.5	19	01061#05	G1SWEM10
12	36.2	22.8	9.5	26.0	12.5	19.0	20.6	22	01061#06	G1SWEM12
14	38.2	24.4	11.0	26.0	12.5	23.0	23.8	27	01061#07	G1SWEM14
16	38.2	24.4	13.0	27.0	13.0	23.8	23.8	27	01061#08	G1SWEM16
20	47.4	28.9	16.0	28.0	14.0	27.0	35	32	01061#09	G1SWEM20
22	47.6	29.1	18.5	30.0	14.0	30.0	35	32	01061#10	G1SWEM22
25	50.2	32.4	22.0	37.0	14.0	33.5	35	38	01061#11	G1SWEM25

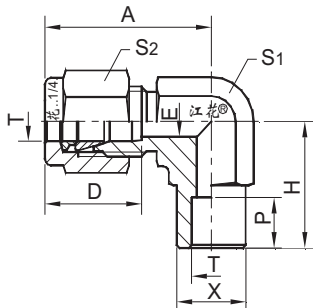
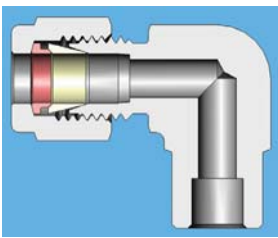

SWE

承插焊弯通接头 (英制管)

Tube Socket Weld Elbow (For fractional tube)

Tube O.D.	A	D	E	H	P	X	S1	S2	Product No.	Type
T									产品编号	型号
1/8	23.9	12.9	2.5	16.0	4.0	9.5	11.1	12	01062#01	G1SWE1/8
3/16	26.7	14.6	3.0	17.5	5.0	11.0	12.7	12	01062#02	G1SWE3/16
1/4	27.3	15.5	5.0	19.6	6.5	12.7	12.7	14	01062#03	G1SWE1/4
3/8	31.5	17.9	7.0	23.0	8.5	15.9	15.9	18	01062#04	G1SWE3/8
1/2	36.2	22.8	10.5	26.0	10.5	19.5	20.6	22	01062#05	G1SWE1/2
5/8	36.5	24.4	13.0	27.0	12.5	23.8	23.8	27	01062#06	G1SWE5/8
3/4	42.4	26.9	16.0	28.0	13.0	27.0	27	30	01062#07	G1SWE3/4
1	50.3	32.5	22.0	37.0	14.0	35.0	35	38	01062#08	G1SWE1

TURM

管梢变径接头 (米制管)

Tube End Reducer (For metric tube)

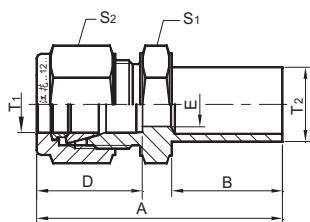
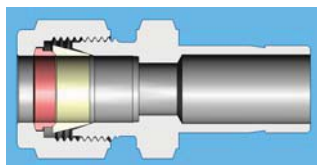

Tube O.D. T1	Tube O.D. T2	A	B	D	E	S1	S2	Product No. 产品编号	Type 型号
3	4	35.4	14.3	12.9	2.0	12	12	01063#01	G1TURM3-4
	6	36.4	15.9		2.5	12		01063#02	G1TURM3-6
	10	38.9	17.7		2.5	14		01063#03	G1TURM3-10
4	6	38.0	15.9	14.5	3.0	12	12	01063#04	G1TURM4-6
6	3	37.0	13.5	15.5	1.5	14	14	01063#05	G1TURM6-3
	8	40.0	16.7		4.8			01063#06	G1TURM6-8
	10	41.0	17.5		4.8			01063#07	G1TURM6-10
	12	46.5	23.0		4.8			01063#08	G1TURM6-12
8	6	40.7	15.9	16.7	4.0	15	17	01063#09	G1TURM8-6
	10	42.7	17.5		6.5			01063#10	G1TURM8-10
	12	48.2	23.0		6.5			01063#11	G1TURM8-12
10	6	42.4	15.9	17.9	4.0	18	19	01063#12	G1TURM10-6
	8	44.2	15.3		5.6			01063#13	G1TURM10-8
	12	50.4	23.0		8.0			01063#14	G1TURM10-12
	15	52.1	23.8		8.0			01063#15	G1TURM10-15
12	6	45.1	15.9	22.8	4.0	22	22	01063#16	G1TURM12-6
	10	46.8	17.5		7.5			01063#17	G1TURM12-10
	16	54.0	24.6		9.5			01063#18	G1TURM12-16
	18	54.0	24.6		9.5			01063#19	G1TURM12-18
	20	56.3	25.4		9.5			01063#20	G1TURM12-20
	25	61.3	31.8		9.5	27		01063#21	G1TURM12-25
16	12	53.3	23.0	24.4	9.0	24	27	01063#22	G1TURM16-12
	18	54.8	24.8		13.0			01063#23	G1TURM16-18
	20	55.5	25.6		13.0			01063#24	G1TURM16-20
	25	62.1	32.0		13.0	27		01063#25	G1TURM16-25
18	12	57.4	23.0	26.9	9.0	27	30	01063#26	G1TURM18-12
	16	58.9	24.6		13.0			01063#27	G1TURM18-16
	20	60.4	25.4		15.0			01063#28	G1TURM18-20
	22	58.9	26.2		15.0			01063#29	G1TURM18-22
	25	65.4	31.8		15.0			01063#30	G1TURM18-25
20	16	60.7	24.6	28.9	12.7	30	32	01063#31	G1TURM20-16
	18	60.7	24.6		14.0			01063#32	G1TURM20-18
	22	60.7	26.2		16.0			01063#33	G1TURM20-22
	25	66.9	31.8		16.0			01063#34	G1TURM20-25
25	16	64.4	24.8	32.5	12.7	36	38	01063#35	G1TURM25-16
	18	64.4	24.6		14.0			01063#36	G1TURM25-18
	20	65.7	25.4		15.1			01063#37	G1TURM25-20

TUR

管梢变径接头 (英制管)

Tube End Reducer (For fractional tube)

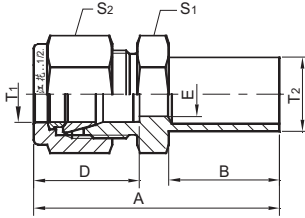
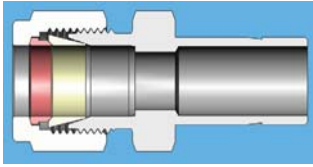

Tube O.D. T1	Tube O.D. T2	A	B	D	E	S1	S2	Product No. 产品编号	Type 型号
1/8	1/8	34.6	13.7	12.9	1.8	12	12	01064#01	G1TUR1/8-1/8
	3/16	34.6	14.7		2.5	12		01064#02	G1TUR1/8-3/16
	1/4	36.4	16.0		2.5	12		01064#03	G1TUR1/8-1/4
	3/8	37.9	17.5		2.5	12		01064#04	G1TUR1/8-3/8
	1/2	44.5	23.0		2.5	14		01064#05	G1TUR1/8-1/2
3/16	1/8	35.8	13.5	13.7	2.0	12	12	01064#06	G1TUR3/16-1/8
	1/4	38.1	16.0		3.3			01064#07	G1TUR3/16-1/4
1/4	1/8	37.0	13.5	15.2	2.0	14	14	01064#08	G1TUR1/4-1/8
	3/16	37.7	14.2		3.0	14		01064#09	G1TUR1/4-3/16
	1/4	39.3	16.0		4.8	14		01064#10	G1TUR1/4-1/4
	5/16	40.0	16.8		4.8	14		01064#11	G1TUR1/4-5/16
	3/8	40.8	17.5		4.8	14		01064#12	G1TUR1/4-3/8
	1/2	46.4	23.0		4.8	14		01064#13	G1TUR1/4-1/2
	5/8	48.1	24.6		4.8	17		01064#14	G1TUR1/4-5/8
	3/4	48.1	24.6		4.8	22		01064#15	G1TUR1/4-3/4
5/16	3/8	42.7	17.5	16.3	6.4	15	17	01064#16	G1TUR5/16-3/8
	1/2	48.3	23.0		6.4			01064#17	G1TUR5/16-1/2
3/8	1/4	42.4	16.0	16.8	4.8	17	18	01064#18	G1TUR3/8-1/4
	3/8	44.2	17.5		7.0	17		01064#19	G1TUR3/8-3/8
	1/2	49.5	23.0		7.0	17		01064#20	G1TUR3/8-1/2
	5/8	51.3	24.6		7.0	17		01064#21	G1TUR3/8-5/8
	3/4	51.3	24.6		7.0	22		01064#22	G1TUR3/8-3/4
1/2	1/4	45.1	16.0	22.9	10.5	22	22	01064#23	G1TUR1/2-1/4
	3/8	46.9	17.5			22		01064#24	G1TUR1/2-3/8
	5/8	54.0	24.6			22		01064#25	G1TUR1/2-5/8
	3/4	54.0	24.6			22		01064#26	G1TUR1/2-3/4
	1	60.3	31.0			27		01064#27	G1TUR1/2-1
5/8	3/4	54.75	24.6	24.4	13.0	24	27	01064#28	G1TUR5/8-3/4
	7/8	56.27	26.2			24		01064#29	G1TUR5/8-7/8
	1	61.1	31.0			27		01064#30	G1TUR5/8-1
3/4	1/2	57.4	23.0	24.4	9.9	27	30	01064#31	G1TUR3/4-1/2
	1	65.2	31.0		16.0			01064#32	G1TUR3/4-1

TUCM

管梢转换接头 (米制管)

Tube End Converter (For metric tube to inch Stub)

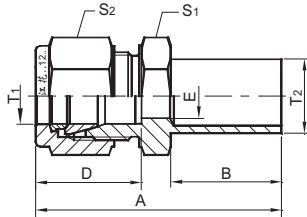
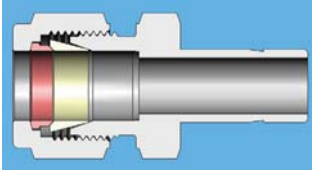

Tube O.D. T1	Tube O.D. T2	A	B	D	E	S1	S2	Product No. 产品编号	Type 型号
3	1/8	34.6	13.5	12.9	1.4	12	12	01064#01	G1TUCM3-1/8
	1/4	36.4	16.0		2.5	12		01064#02	G1TUCM3-1/4
6	1/4	39.3	16.0	15.5	4.8	14	14	01064#03	G1TUCM6-1/4
	3/8	40.0	16.8		4.8			01064#04	G1TUCM6-3/8
	5/8	40.8	17.5		4.8			01064#05	G1TUCM6-5/8
	1/2	46.4	23.0		4.8			01064#06	G1TUCM6-1/2
8	3/8	42.7	17.5	16.7	6.5	15	17	01064#07	G1TUCM8-3/8
	1/2	48.3	23.0		6.5			01064#08	G1TUCM8-1/2
10	3/8	45.2	17.5	17.9	7.0	18	19	01064#09	G1TUCM10-3/8
	1/2	49.8	23.0		7.0			01064#10	G1TUCM10-1/2
12	1/2	52.5	23.0	22.8	9.5	22	22	01064#11	G1TUCM12-1/2
	3/4	54.0	24.6		9.5			01064#12	G1TUCM12-3/4
18	3/4	60.4	24.6	26.9	15.0	27	30	01064#13	G1TUCM18-3/4

PLM

堵头 (米制管)

Plug (for metric tube)



Tube O.D. T	Product No. 产品编号	Type 型号
3	01065#01	G1PLM3
4	01065#02	G1PLM4
6	01065#03	G1PLM6
8	01065#04	G1PLM8
10	01065#05	G1PLM10
12	01065#06	G1PLM12
14	01065#07	G1PLM14
15	01065#08	G1PLM15
16	01065#09	G1PLM16
18	01065#10	G1PLM18
20	01065#11	G1PLM20
22	01065#12	G1PLM22
25	01065#13	G1PLM25

PL

堵头 (英制管)

Plug (for fractional tube)

Tube O.D. T	Product No. 产品编号	Type 型号
1/8	01065#01	G1PL1/8
3/16	01065#02	G1PL3/16
1/4	01065#03	G1PL1/4
5/16	01065#04	G1PL5/16
3/8	01065#05	G1PL3/8
1/2	01065#06	G1PL1/2
5/8	01065#07	G1PL5/8
3/4	01065#08	G1PL3/4
7/8	01065#09	G1PL7/8
1	01065#10	G1PL1

CAPM

管帽 (米制管)

Cap (For metric tube)

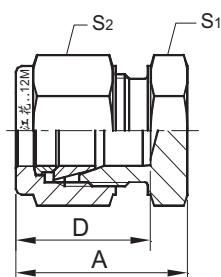
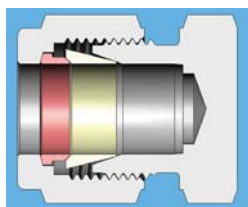

Tube O.D.					Product No.	Type
T	A	D	S1	S2	产品编号	型号
3	20.4	12.9	10	12	01066#01	G1CAPM3
4	22.2	14.5	12	12	01066#02	G1CAPM4
6	23.2	15.5	14	14	01066#03	G1CAPM6
8	25.2	16.7	15	17	01066#04	G1CAPM8
10	26.4	17.9	18	19	01066#05	G1CAPM10
12	29.3	22.8	22	22	01066#06	G1CAPM12
14	30.3	24.4	24	27	01066#07	G1CAPM14
15	30.3	24.4	24	27	01066#08	G1CAPM15
16	30.3	24.4	24	27	01066#09	G1CAPM16
18	34.2	26.9	27	30	01066#10	G1CAPM18
20	36.9	28.9	30	32	01066#11	G1CAPM20
22	37.1	29.1	30	32	01066#12	G1CAPM22
25	39.6	32.4	36	38	01066#13	G1CAPM25

CAP

管帽 (英制管)

Cap (For fractional tube)

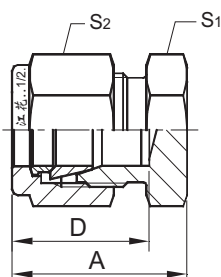
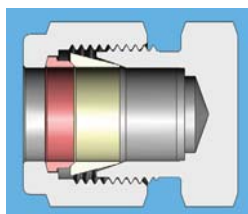

Tube O.D.					Product No.	Type
T	A	D	S1	S2	产品编号	型号
1/8	20.4	12.9	10	12	01067#01	G1CAP1/8
3/16	22.6	14.6	12	12	01067#02	G1CAP3/16
1/4	23.5	15.5	14	14	01067#03	G1CAP1/4
5/16	25.2	16.7	15	17	01067#04	G1CAP5/16
3/8	26.4	17.9	17	18	01067#05	G1CAP3/8
1/2	29.3	22.8	22	22	01067#06	G1CAP1/2
5/8	30.3	24.4	24	27	01067#07	G1CAP5/8
3/4	34.2	26.9	27	30	01067#08	G1CAP3/4
7/8	37.1	29.1	30	32	01067#09	G1CAP7/8
1	39.7	32.5	36	38	01067#10	G1CAP1

FFM

前卡套 (米制管)

Fronnd ferrule (for metric tube)

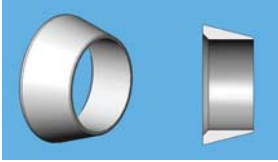

Tube O.D. T	Product No. 产品编号	Type 型号
3	01068#01	G1FFM3
4	01068#02	G1FFM4
6	01068#03	G1FFM6
8	01068#04	G1FFM8
10	01068#05	G1FFM10
12	01068#06	G1FFM12
14	01068#07	G1FFM14
15	01068#08	G1FFM15
16	01068#09	G1FFM16
18	01068#10	G1FFM18
20	01068#11	G1FFM20
22	01068#12	G1FFM22
25	01068#13	G1FFM25

FF

前卡套 (英制管)

Fronnd ferrule (for fractional tube)

Tube O.D. T	Product No. 产品编号	Type 型号
1/8	01069#01	G1FF1/8
3/16	01069#02	G1FF3/16
1/4	01069#03	G1FF1/4
5/16	01069#04	G1FF5/16
3/8	01069#05	G1FF3/8
1/2	01069#06	G1FF1/2
5/8	01069#07	G1FF5/8
3/4	01069#08	G1FF3/4
7/8	01069#09	G1FF7/8
1	01069#10	G1FF1

BFM

后卡套 (米制管)

Back ferrule (for metric tube)

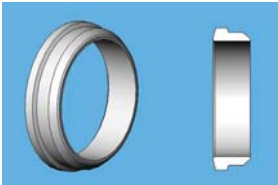

Tube O.D. T	Product No. 产品编号	Type 型号
3	01070#01	G1BFM3
4	01070#02	G1BFM4
6	01070#03	G1BFM6
8	01070#04	G1BFM8
10	01070#05	G1BFM10
12	01070#06	G1BFM12
14	01070#07	G1BFM14
15	01070#08	G1BFM15
16	01070#09	G1BFM16
18	01070#10	G1BFM18
20	01070#11	G1BFM20
22	01070#12	G1BFM22
25	01070#13	G1BFM25

BF

后卡套 (英制管)

Back ferrule (for fractional tube)

Tube O.D. T	Product No. 产品编号	Type 型号
1/8	01071#01	G1BF1/8
3/16	01071#02	G1BF3/16
1/4	01071#03	G1BF1/4
5/16	01071#04	G1BF5/16
3/8	01071#05	G1BF3/8
1/2	01071#06	G1BF1/2
5/8	01071#07	G1BF5/8
3/4	01071#08	G1BF3/4
7/8	01071#09	G1BF7/8
1	01071#10	G1BF1

中国石化物资资源市场成员厂
ISO9001:2000 质量体系认证企业



镇江市华阳机电制造有限公司
Zhenjiang Huayang M&E Manufacturing Co., Ltd
地址: 江苏扬中市丰裕工业区
Add: Fengyu Industrial Park Yangzhong, Jiangsu
邮编 Postcode: 212213
电话 Tel: 0511-8431885, 8431824
传真 Fax:: 0511-8431333, 8431804
E-mail: huayang@huayangcompany.com
huayang@vip.163.com
http: www.huayangcompany.com
